



OUTLINE

KITCHENS, BEDROOMS & HOME OFFICE

Your favourite door families, just not as you know them.





CONTENTS

INTRODUCING OUTLINE	3
Designed and supplied from the UK	6
Frontal Options	8
Handle Design Options	10
Backplate Options	13
Collection Overview	16
Painted Palette	17
Picture every kitchen possibility	18
How to Order	20
RANGE CONTENT	23
- Porter	24
- Hunton	58
- Fitzroy	72
- Crathorne	94
- Mornington Shaker	108
- Mornington Beaded	112
PLANNING WITH OUTLINE	125
The Basics	127
Base Units	128
Drawer Packs	130
Wall Units	132
Larder Units	134
Internal Storage	140
Integrated Appliances	142
Bedroom Range Matrix	144
Home Office Range Matrix	146
REPLICATE THE LOOK	149
KITCHENS	
- Porter Portal	150
- Mornington Shaker Edge	156
- Hunton Edge	162
- Porter Channel and Extended Channel	168
BEDROOMS	
- Porter Portal	176
- Mornington Beaded Edge	180
HOME OFFICE	
- Porter Extended Channel	184
- Hunton Edge	188
COMPLEMENTING HANDLES	193
HELPING YOU SELL OUTLINE	202



INTRODUCING OUTLINE

**A new and exciting integrated handle collection from PWS.
A collection like no other, it is an innovative, flexible and
commercially appealing range of frontals with a difference.**

Meeting the growing consumer demand for more personalised and tailored furniture, Outline combines our most popular door families with a selection of integrated handle options to offer the consumer the look and feel of a bespoke, premium kitchen, bedroom or home office but at a more affordable price point.



Following extensive research and development by the in-house PWS team, Outline combines aesthetic design, practicality, and durability with craftsmanship and intricate manufacturing techniques to offer a distinctive and original collection at an attractive price for retailers.

Outline is supported by a simple online ordering platform and comprehensive suite of materials so it is easy to plan, design and order.

STAND OUT FROM THE CROWD

**A first for the independent sector, this unique collection
allows you to enter a growing area of the market, stand out
from the crowd and ultimately win more business.**

www.pws.co.uk/outline



OVER 2,500 DESIGN POSSIBILITIES

Outline features a wide array of options so you can design unique room settings, individual to your customers tastes and needs. The Outline collection features...

6 of our most popular door families...

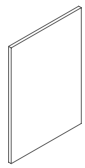

PORTER

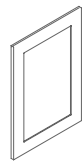

HUNTON

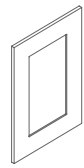

FITZROY

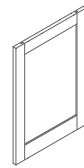

CRATHORNE

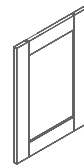

MORNINGTON
SHAKER

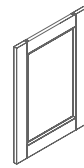

MORNINGTON
BEADED

In any of our 35 painted colour options.



4 integrated handle options, in a wide variety of locations.

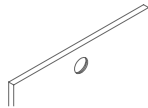

PORTAL

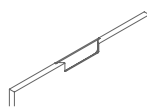

EDGE

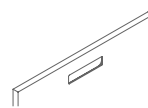

CHANNEL

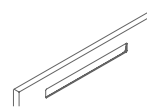

EXTENDED
CHANNEL

8 backplate finishes, including timber, painted and metallic options.



Visit www.pws.co.uk/outline to explore the Outline Configurator and discover over 2,500 design possibilities.

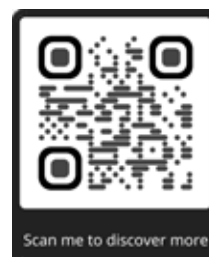

Scan me to discover more

DESIGNED AND SUPPLIED FROM THE UK

We have heavily invested in our state-of-the-art manufacturing facility and pushed our machinery to its full capability to introduce a bespoke service that can set you apart from your competitors.



STOCKED IN THE UK

All door families are ready to be picked off the shelf, ready to undergo their Outline journey at our UK headquarters.

INTRICATE JOINERY

Your chosen handle is then carefully crafted into the door using the latest manufacturing technology for a smooth and consistent finish. Specialist priming technology then prepares the door for paint adhesion.





A SUPERIOR FINISH

Doors then make their way through our fully automated paint process, where all our FIRA Certified paint has been machine mixed in-house. Employing the very latest technological innovations and manufacturing techniques, it guarantees a superior quality of finish.

QUALITY MATTERS

Our super-scale dust extraction and filtration network cleans the air in the whole building every hour, to minimise any imperfections. After being painted, doors are left to dry in a specially designed oven, before they undergo a rigorous and thorough testing process to ensure they are fit for purpose and stand up to our high expectations.



TAKE THE HASSLE OUT OF DRILLING

By using our specially developed drilling service, you can significantly reduce potential damages and have orders delivered direct to site, ready to be fitted - making things simpler and quicker for you.



*Subject to capacity

LEAD-TIMES

The stated lead-times are for guidance purposes only and always subject to manufacturing capacity. An accurate lead-time, in the form of a delivery date, will be confirmed with each individual order acknowledgement.

FRONTAL OPTIONS



*Subject to capacity

AVAILABLE IN 5 DOOR FAMILIES

Outline includes our most popular door families. From Porter, our best-selling slab, to Mornington, our beloved woodgrain Shaker, you can create a vast array of looks to suit any modern or traditional setting.

By evolving our existing door families and utilising our industry-leading paint service, we have made it easy for you to create something truly unique using products you already know.

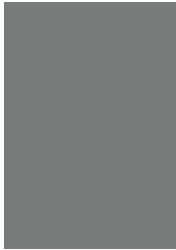

PORTER

- page 24

Our best-selling modern door family, this clean and linear slab comes with a wide selection of accessories to create stunning contemporary environments.

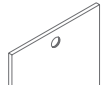

PORTAL

Page 26



EDGE

Page 34

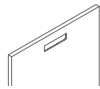

CHANNEL

Page 42

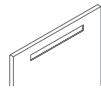

EXTENDED CHANNEL

Page 50

8 STOCKED COLOURS - PREFIX PSO

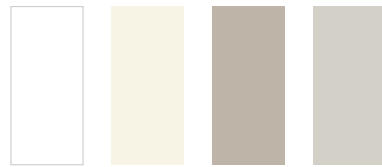

WHITE PORCELAIN CASHMERE DOVE GREY



SILVER GREY DUST GREY GRAPHITE HARTFORTH BLUE

PLUS FURTHER PAINT-TO-ORDER COLOURS - PREFIX PXO

Available in a Matt finish only



HUNTON

- page 58

A unique, modern Shaker, Hunton features a narrow frame design, one-piece construction, and smooth painted finish to create a truly versatile Shaker that suits any room setting.

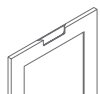

EDGE

Page 60

4 STOCKED COLOURS - PREFIX HSO



PORCELAIN DOVE GREY DUST GREY HARTFORTH BLUE

PLUS FURTHER PAINT-TO-ORDER COLOURS - PREFIX HXO



FITZROY

- page 72

Our popular, single piece Shaker works equally well in both modern and classic settings. Fitzroy's classic proportions and smooth painted finish combine to create a classic door range with a modern touch.

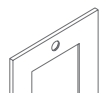

PORTAL

Page 74

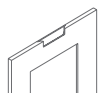

EDGE

Page 84

5 STOCKED COLOURS - PREFIX FSO



PORCELAIN STONE DOVE GREY PARTRIDGE GREY HARTFORTH BLUE

PLUS FURTHER PAINT-TO-ORDER COLOURS - PREFIX FXO



CRATHORNE

- page 94

A contemporary twist on the traditional Shaker, Crathorne features an elegant narrow frame design, and a distinctive ash grain texture.

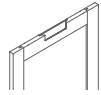

EDGE

Page 96

4 STOCKED COLOURS - PREFIX CSO



PORCELAIN DOVE GREY REGIMENT HARTFORTH BLUE

PLUS FURTHER PAINT-TO-ORDER COLOURS -  PREFIX CXO



MORNINGTON SHAKER

- page 108

Our best-selling Shaker family features a 5-piece real timber construction, narrow frame design and distinctive ash grain texture, to make Mornington Shaker our most popular classic door family.



EDGE

Page 110

8 STOCKED COLOURS - PREFIX MGSO



PORCELAIN STONE DOVE GREY PARTRIDGE GREY



REGIMENT DUST GREY GRAPHITE HARTFORTH BLUE

PLUS FURTHER PAINT-TO-ORDER COLOURS -  PREFIX MGXO



MORNINGTON BEADED

- page 112

An evolution of our in-demand Shaker, Mornington Beaded offers the same features and benefits but with the addition of a decorative quarter round beading detail.



EDGE

Page 114

7 STOCKED COLOURS - PREFIX MBSO



PORCELAIN STONE DOVE GREY PARTRIDGE GREY



DUST GREY GRAPHITE HARTFORTH BLUE

PLUS FURTHER PAINT-TO-ORDER COLOURS -  PREFIX MBXO

HANDLE DESIGN OPTIONS

CHOOSE FROM 4 UNIQUE DESIGNED

Outline features four distinct handle options - each acting as a key element in your design. Specially developed to complement our existing doors families, each handle type features its own unique character and charm.

PORTAL

The circular shape of Portal is an elegant, and soft handle choice. Working particularly well when paired with a modern slab, its playful, Scandinavian-inspired design captures an eclectic, and somewhat retro feel.

A timeless shape that delivers optimal grip for the user, Portal draws the eye, revealing just enough of its round backplates to add a bold, crafted detail to your design.

Shown on Porter



EDGE

Subtly sculpted into the perimeter of the door, Edge offers a refined and considered handle that is as attractive as it is functional. Appearing to be at one with the frontal, its slightly radius corners soften the overall design for an inviting, unified appearance.

Our most flexible handle choice, it is equally suited to modern and traditional settings. Use it to add depth and interest to minimal slabs or pair with a Shaker to complement natural timber frames.

Shown on Hunton



CHANNEL

The rectangular, linear appearance of Channel offers a contemporary and reserved handle that emphasises flow and movement.

This sophisticated shape features slightly rounded edges and a striking rectangular backplate, to create an ergonomic handle that empathises the modern nature of slab frontals.

Shown on Porter



EXTENDED CHANNEL

A natural evolution of Channel, Extended Channel's bold, geometric shape creates an ultra-modern appearance. Slightly rounded edges and elongated backplates combine to deliver a functional yet adventurous handle.

Its streamlined shape naturally complements modern slab doors, particularly when used on wider drawer packs and feature islands. With a clear Germanic influence, Extended Channel is perfect for those wanting a design that oozes symmetry and balance.

Shown on Porter



BACKPLATE OPTIONS

SELECT FROM 8 BACKPLATES

Key to the appeal of Outline is its array of distinctive backplates. Choose from a wide selection of complementary backplate finishes, including timber, painted (below) and metallic options (over page).

4 mm TIMBER BACKPLATES



OAK

A timeless finish that will never go out of fashion. Oak's classic style allows you to bring an element of the outside, inside, and effortlessly complements darker, natural tones.



WALNUT

Rich Walnut offers a deep and dark feature. This very traditional finish pairs perfectly with bold, earthy tones to enhance a warm and welcoming setting.

4 mm PAINTED BACKPLATES



MATCHING

Achieve a unifying, single colour look by matching your backplates to the colour and finish of your chosen doors. Available to match any of our 35 paint-to-order colours.



CARBON (SMOOTH FINISH)

Intense Carbon stands proud as a feature all on its own. Coming in a smooth finish, Carbon works particularly well when paired with lighter colours to create a contrasting, monochrome look.



BACKPLATE OPTIONS

2mm METALLIC BACKPLATES



ANTIQUE BRONZE EFFECT

Bursting with character, Antique Bronze is an opulent backplate option. Featuring a strong, warm finish with subtle brushing effect, this is a timeless choice.



AGED BRASS

A rustic, mottled finish encapsulates the traditional appearance of Aged Brass. Its natural, patina appearance creates a richly metallic detail that can add extra elements of interest to a design.



BRIGHT COPPER

A bright and modern option. The rich and bold finish of Bright Copper features a subtle brushing effect and highly reflective finish for those looking for a distinctive backplate.



BRUSHED BRASS

A modern brass that pairs well with lighter tones. The delicate, brushed effect gently reflects light to offer a more polished backplate that is satiny in appearance.

COLLECTION OVERVIEW

9 COMBINATIONS AVAILABLE

This flexible collection features four handle types and five door families that have been specifically designed to work together and complement each other. The table below highlights which of our handle types are available on which door families.

	 PORTAL	 EDGE	 CHANNEL	 EXTENDED CHANNEL
PORTER	✓	✓	✓	✓
HUNTON	-	✓	-	-
FITZROY*	✓	✓	-	-
CRATHORNE*		✓		
MORNINGTON SHAKER*	-	✓	-	-
MORNINGTON BEADED	-	✓	-	-

*Fitzroy, Crathorne and Mornington Shaker are not available in Bedrooms sizes whilst Fitzroy is also not available in Home Office sizes.

PAINTED PALETTE

35 COLOURS AVAILABLE

Outline doors are available in any of our 35 colours. Meticulously created by our industry-leading design team, this carefully selected palette allows you to create a design that reflects your individual style. Depending on the door range you choose, your colour will be either a Stocked Colour or be a Paint-to-order colour option.

You can even have your backplate painted in the same shade for a unified, single colour look. Simply select our matching backplate option.

NEUTRALS



WHITE CHALK PORCELAIN ALABASTER MODERN MUSSEL STONE



GREYS



DOVE GREY SILVER GREY PUTTY DUST GREY SLATE GRAPHITE CARBON

WARM NEUTRALS



CASHMERE DRY ROSE PIMENTO GEORGIAN RED TRUFFLE LAVA

OLIVE GREENS



SAGE OLIVE BAY GREEN

FOREST GREENS



REGIMENT REGENTS GREEN COPSE GREEN

GREEN BLUES



PARTRIDGE GREY CHINA BLUE CHALK BLUE STORM BLUE HARTFORTH BLUE CHARCOAL

INK BLUES



IVES BLUE CADET CORNFLOWER INKWELL

LEAD-TIMES

The stated lead-times are for guidance purposes only and always subject to manufacturing capacity. An accurate lead-time, in the form of a delivery date, will be confirmed with each individual order acknowledgement.

PLEASE NOTE

Because of the variables between the photographic and print process, colours shown in print may vary slightly from the actual product supplied.

Outline is only available in a Matt finish.

PICTURE EVERY KITCHEN POSSIBILITY

Mix and match all the possibilities to find the perfect combination

We have developed an Outline Configurator so you and your customers can explore the wealth of personalised and tailored kitchens available with Outline.

Available online, this handy tool is the easiest way to explore our collection, discover all the door styles, available colours, and selection of backplates.

You can edit the configurator combinations in two ways, either by clicking on the door ranges and edit in the left hand bar, or by clicking the pencils below.



Select from 5 of our most popular door families

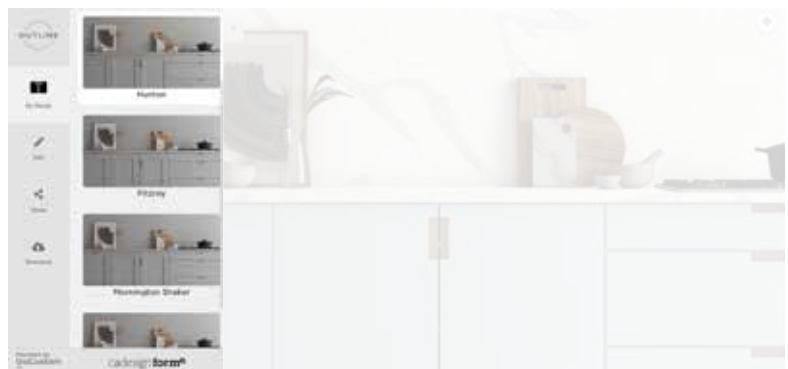

Available in any of our 35 colour options

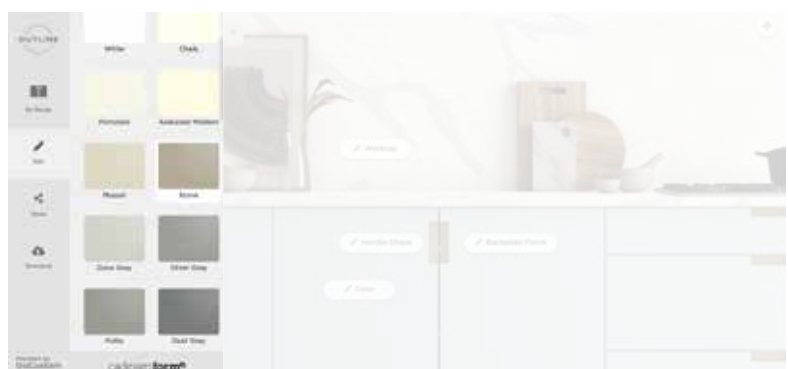

Choose your integrated handle

- options available will depend on your door selection



Choose from 8 backplate finishes

- including timber, painted and metallic options

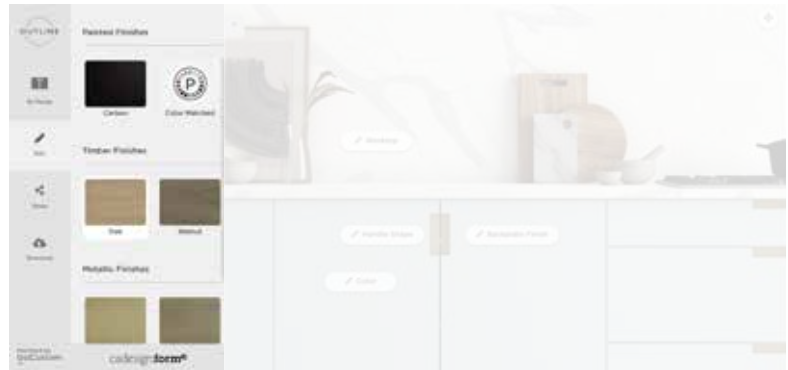

Finally select a complementary worksurface to refine the overall look



When you're happy, you can then share your design on your social channels to show your customers what you can create, or download it as an image or a pdf to share directly with customers, or attach it to your design proposals.



Use the Outline Configurator to visualise your customer's dream kitchen, stand out from the crowd and ultimately win more business.

www.pws.co.uk/outline

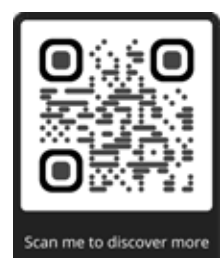

Scan me to discover more
www.pws.co.uk/outline

HOW TO ORDER

THE EASIEST WAY TO ORDER IS ONLINE

Developed with retailers in mind, we have gone to great lengths to make it as simple as possible for you to plan, quote and order Outline.

The easiest way to order Outline is online. Effortlessly browse and order products anytime from any location with our easy-to-use step-by-step ordering platform. Simply follow the steps below to order any of the Outline collection.

Should you wish to order Outline using an order form, please contact your Account Manager or visit www.pws.co.uk

STEP 1

Firstly, select your chosen door family and room of choice from the Doors drop down. Then select whether it is a stocked or Paint-to-order colour. Then simply chose your frontal from the list of product codes.

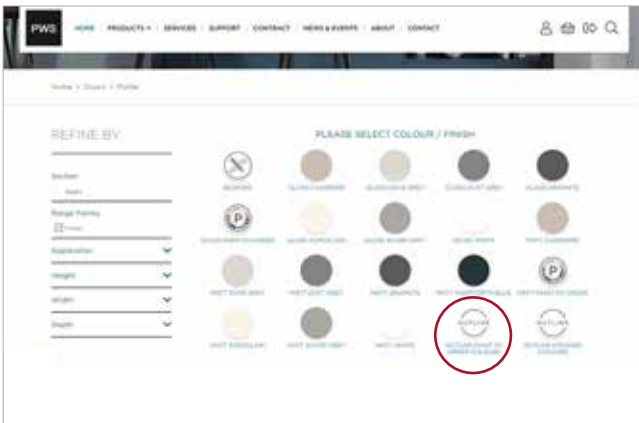

Alternatively, enter the full product code in the Order Area.

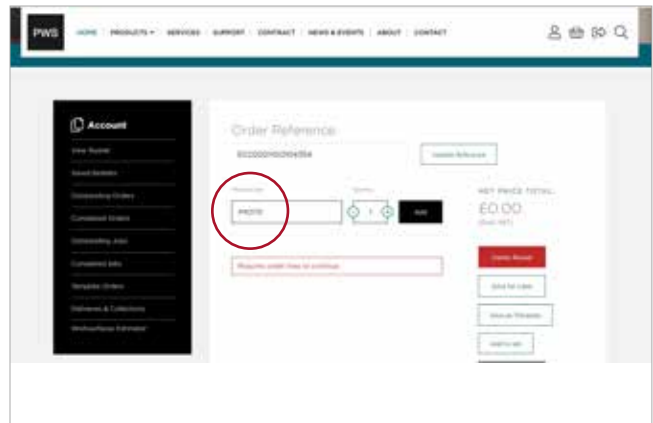

STEP 2

Choose your colour from the options available

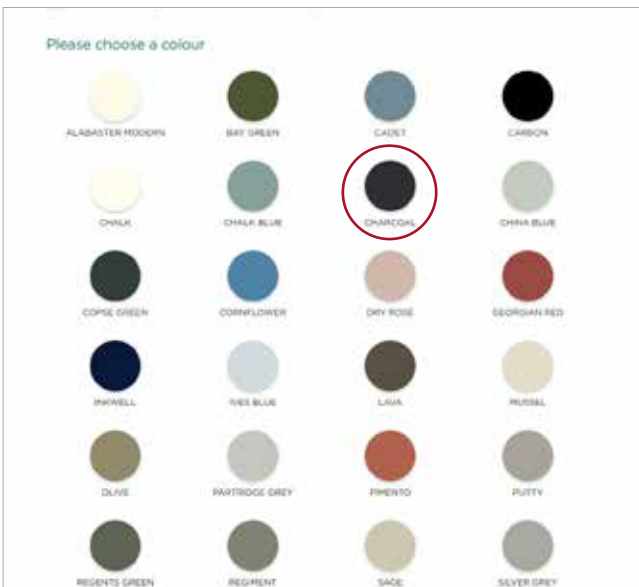

STEP 3

Choose your handle

You can even save your door, colour, and handle preferences so you don't have to repeat these steps for every frontal. Simply select 'Remember my choices for the rest of your order' to save yourself some time.

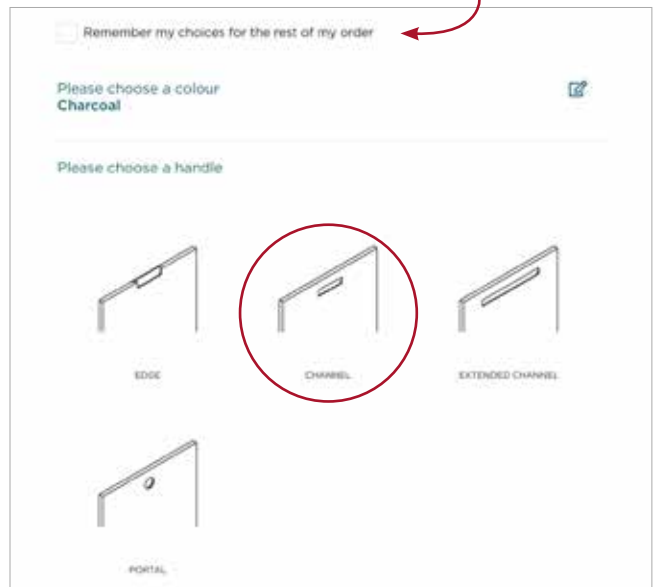

STEP 4

Choose your backplate finish - 8 options available



STEP 5

Choose your handle location - only configurations possible will be shown



You will then see an overview of your selections so you can make sure everything is correct before adding it to your basket.

PX0715
Porter Outline PTO, 715x497mm (slab)
Charcoal, Channel, Matching, Top Right
[+ Add drilling](#)

Order online at
www.pws.co.uk
today



Edge shown with Oak backplate

RANGE CONTENT

PORTER	24
HUNTON	58
FITZROY	72
CRATHORNE	94
MORNINGTON SHAKER	108
MORNINGTON BEADED	112

PORTER



Available in
Kitchens



Available in
Bedrooms



Available in
Home Office

Choose our best-selling modern door family for a clean and linear slab. Coming with a wide selection of accessories it can create stunning contemporary environments.

4 HANDLE OPTIONS AVAILABLE

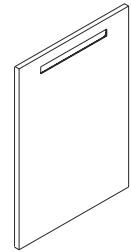
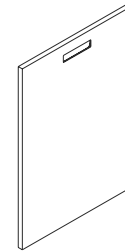
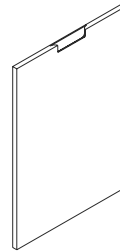
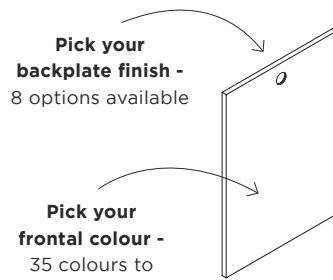

PORTAL

Page 26

EDGE

Page 34

CHANNEL

Page 42

EXTENDED CHANNEL

Page 50



PORTAL

Example shown - Porter Portal,
Frontal: Dry Rose, Backplate: Matching



EDGE

Example shown - Porter Edge,
Frontal: Cadet, Backplate: Brushed Brass



CHANNEL

Example shown - Porter Channel,
Frontal: Regiment, Backplate: Walnut

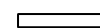

EXTENDED CHANNEL

Example shown - Porter Extended Channel,
Frontal: Carbon, Backplate: Oak

FRONTAL COLOURS

STOCKED COLOURS - PREFIX PSO



- K** Available in Kitchens
- B** Available in Bedrooms
- H** Available in Home Office

PAINT-TO-ORDER COLOURS - PREFIX PXO

NEUTRALS

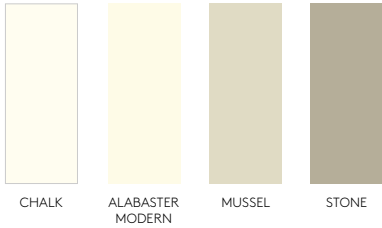

GREYS



WARM NEUTRALS

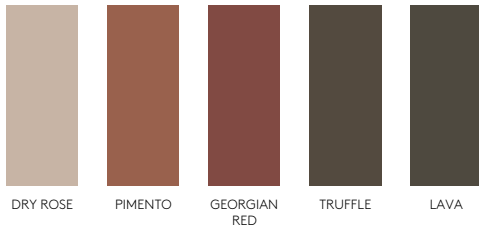

OLIVE GREENS

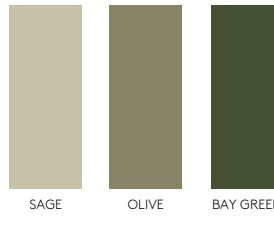

FOREST GREENS

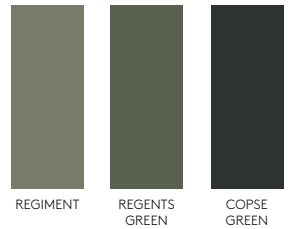

GREEN BLUES

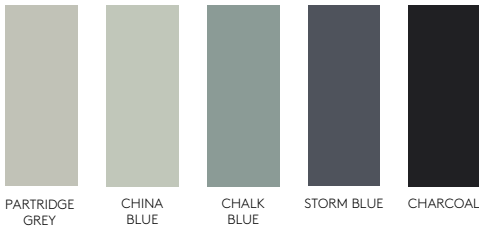

INK BLUES

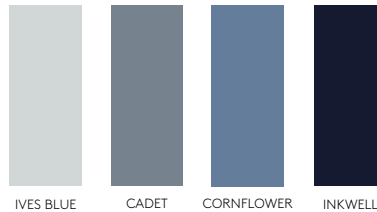

BACKPLATE FINISHES

TIMBER BACKPLATES (4mm)



METALLIC BACKPLATES (2mm)



PAINTED BACKPLATES (4mm)

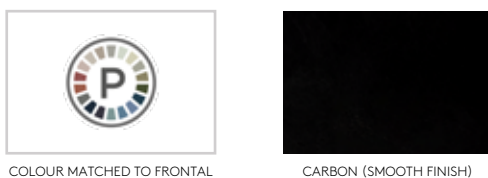

PORTER PORTAL

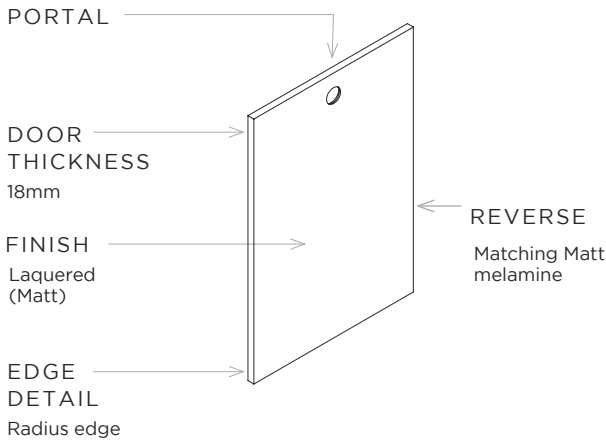

PORTER SPECIFICATION

DOOR FAMILY STYLE	Slab (over-painted)
DOOR THICKNESS	18mm
SUBSTRATE	MDF
FINISH	Painted (matt finish)
REVERSE	Matching matt melamine reverse (PtO - matching matt painted reverse)
CERTIFICATION	Fira Gold

HANDLE LOCATION

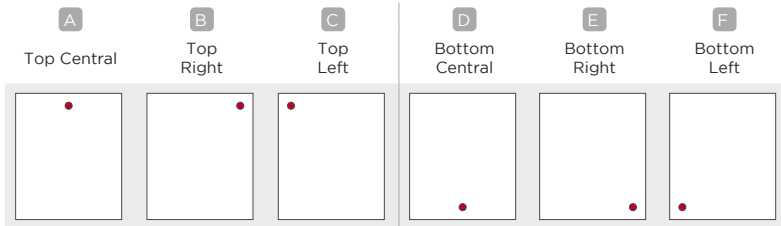

Note: This does not apply to 1965 Larder Doors. Please see page 29 for fixed handle height and lining through details.

HANDLE SPECIFICATION

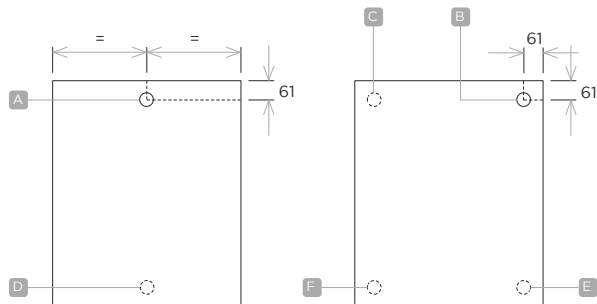

ROUTER SPECIFICATION

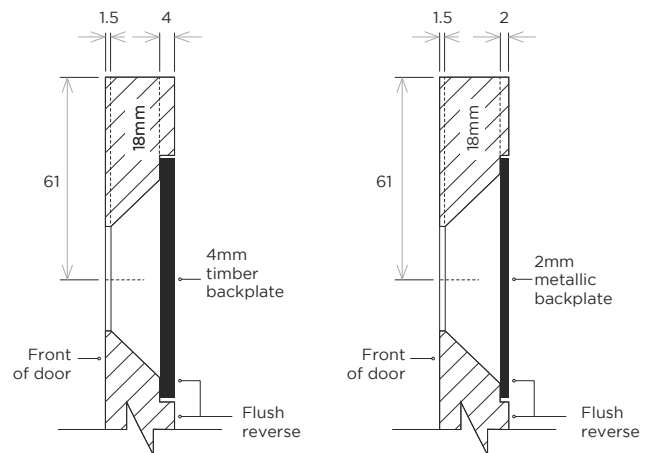

4mm TIMBER BACKPLATES

2mm METALLIC BACKPLATES

Note: For a flush reverse, doors are processed accordingly, to accommodate metallic and timber backplates.



PORTER PORTAL

Code	(HxW)	Top Central
Drawer fronts		
***143	139x297mm	✓
***144	139x397mm	✓
***139X447	139x447mm	✓
***145	139x497mm	✓
***146	139x597mm	✓
***148	139x797mm	✓
***149	139x897mm	✓
***140	139x997mm	✓
***175	175x497mm	✓
***176	175x597mm	✓

KEY INFORMATION

Frontal Prefix Codes
 Stocked - **PSO**
 Paint-to-order - **PXO**

*Subject to capacity

X The following frontal sizes from stocked Porter are not available in Porter Portal

- ***85x597 85x597mm, Vanity Drawer
- ***85x797 85x797mm, Vanity Drawer
- ***85x997 85x997mm, Vanity Drawer
- ***116 115x597mm
- ***715X257 715x257mm, Base Filler Door for Small Curve Door
- ***CDS716 Small Curved Door, 715x300mm
- ***ICW600 Internal Curved Wall Door for 720x720x600x600mm cabinet
- ***ICB900 Internal Curved Base Door for 720x900x900mm cabinet
- ***715FS 715x497mm, Clear Glazed

		Top Central	Top Right	Top Left	Bottom Central	Bottom Right	Bottom Left
Drawer fronts							
***215x397	215x397mm	✓	-	-	✓	-	-
***215x497	215x497mm	✓	-	-	✓	-	-
***215x797	215x797mm	✓	-	-	✓	-	-
***215x997	215x997mm	✓	-	-	✓	-	-
***285	283x497mm	✓	-	-	✓	-	-
***286	283x597mm	✓	-	-	✓	-	-
***288	283x797mm	✓	-	-	✓	-	-
***289	283x897mm	✓	-	-	✓	-	-
***280	283x997mm	✓	-	-	✓	-	-
***353	355x297mm	✓	✓	✓	✓	✓	✓
***355	355x497mm	✓	✓	✓	✓	✓	✓
***356	355x597mm	✓	✓	✓	✓	✓	✓
***358	355x797mm	✓	-	-	✓	-	-
***359	355x897mm	✓	-	-	✓	-	-
***350	355x997mm	✓	-	-	✓	-	-
Doors							
***447X397	447x397mm	✓	✓	✓	✓	✓	✓
***447X447	447x447mm	✓	✓	✓	✓	✓	✓
***447X597	447x597mm	✓	✓	✓	✓	✓	✓
***456	450x597mm	✓	✓	✓	✓	✓	✓
***496	490x597mm	✓	✓	✓	✓	✓	✓
***573	570x297mm	✓	✓	✓	✓	✓	✓
***574	570x397mm	✓	✓	✓	✓	✓	✓
***570X447	570x447mm	✓	✓	✓	✓	✓	✓
***575	570x497mm	✓	✓	✓	✓	✓	✓
***576	570x597mm	✓	✓	✓	✓	✓	✓
***646	645x597mm, for use with single ovens	✓	✓	✓	✓	✓	✓

		Top Central	Top Right	Top Left	Bottom Central	Bottom Right	Bottom Left
Doors							
***715X147	715x147mm	✓	-	-	✓	-	-
***713	715x297mm	✓	✓	✓	✓	✓	✓
***715X347	715x347mm	✓	✓	✓	✓	✓	✓
***714	715x397mm	✓	✓	✓	✓	✓	✓
***715X447	715x447mm	✓	✓	✓	✓	✓	✓
***715	715x497mm	✓	✓	✓	✓	✓	✓
***715x547	715x547mm	✓	✓	✓	✓	✓	✓
***716	715x597mm	✓	✓	✓	✓	✓	✓
***893	895x297mm	✓	✓	✓	✓	✓	✓
***894	895x397mm	✓	✓	✓	✓	✓	✓
***895X447	895x447mm	✓	✓	✓	✓	✓	✓
***895	895x497mm	✓	✓	✓	✓	✓	✓
***896	895x597mm	✓	✓	✓	✓	✓	✓
***986	980x597mm	✓	✓	✓	✓	✓	✓
Larder doors							
***123	1245x297mm	✓	✓	✓	✓	✓	✓
***124	1245x397mm	✓	✓	✓	✓	✓	✓
***125	1245x497mm	✓	✓	✓	✓	✓	✓
***126	1245x597mm	✓	✓	✓	✓	✓	✓

		Fixed Central	Fixed Right	Fixed Left
Tall larder doors				
Note: • 1965mm Larder doors have a fixed handle position to line through with adjacent 715 base doors. • Larder doors are handed				
***193	1965x297mm	✓	✓	✓
***195	1965x497mm	✓	✓	✓
***196	1965x597mm	✓	✓	✓

		Fixed Right	Fixed Left
Robe doors			
Note: • Robe doors are handed			
***2154x397	2154x397mm	✓	✓
***2154x447	2154x447mm	✓	✓
***2154x497	2154x497mm	✓	✓

		Top Central	Top Right	Top Left	Bottom Central	Bottom Right	Bottom Left
Corner doors							
***WCDS	715x277	-	-	-	✓	✓	✓
***CDS	715x315	✓	✓	✓	-	-	-

Note: Corner doors come as a pair. Handle features on one door only.

HANDLE LOCATION

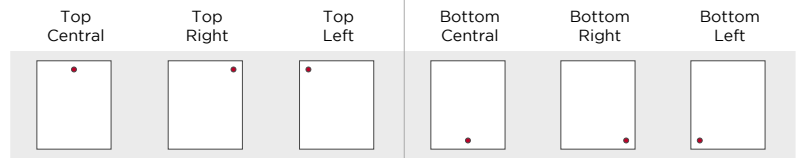

Recommended handle locations are illustrated on the doors below.

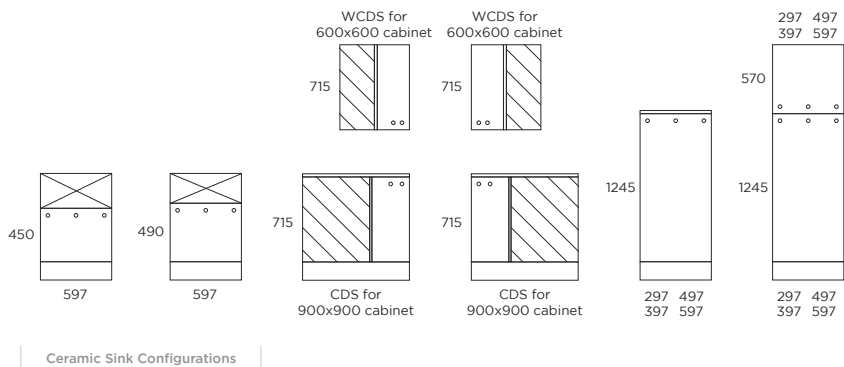
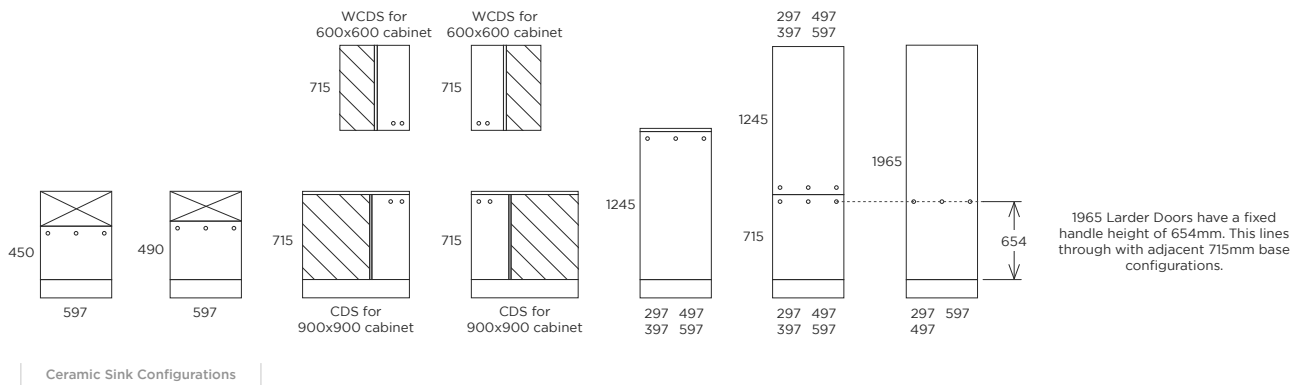
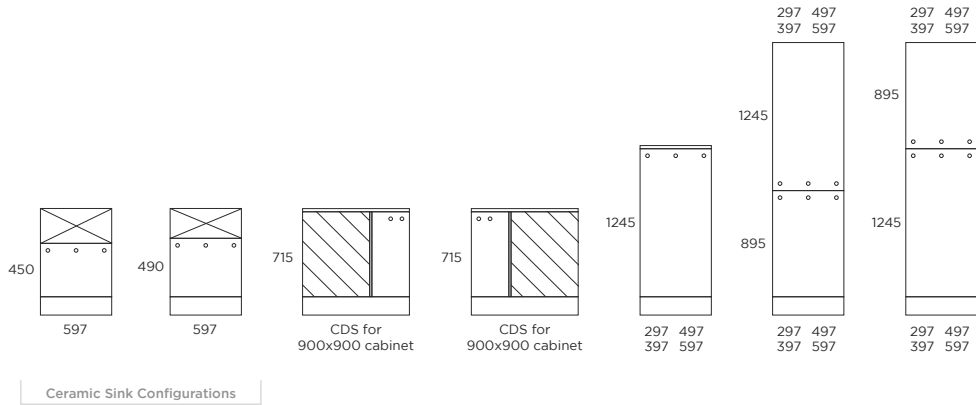

Please note
*Not all handle locations available (please see 'Handle Location Guide' for more information)

PORTER PORTAL

KITCHEN APPLIANCE MATRIX FOR LAY-ON DOORS

This matrix can be referred to when planning built-in appliance housings in Porter Portal. The matrix illustrates industry standard configurations and Portal handle locations, based on stocked sizes from the Porter range. Whilst the majority of these configurations eradicates the need for fillers, there are a few instances where a filler is required (see in matrix).

Please note: Aperture sizes shown with the actual appliance size shown below in brackets.

TALL HEIGHT INSTALLATION

To be used with 600mm wide appliances

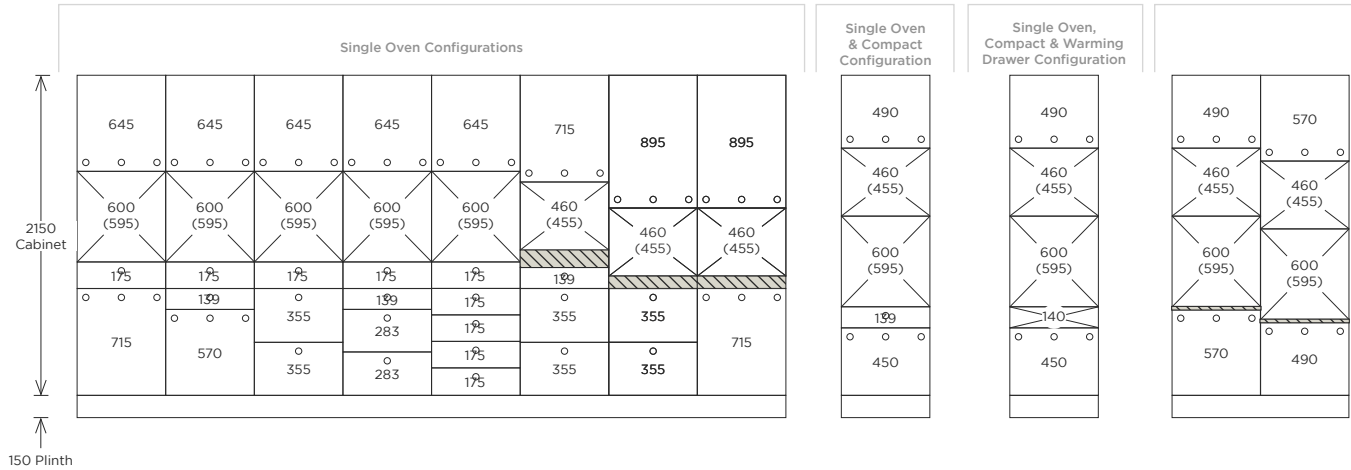

MEDIUM HEIGHT INSTALLATION

To be used with 600mm wide appliances

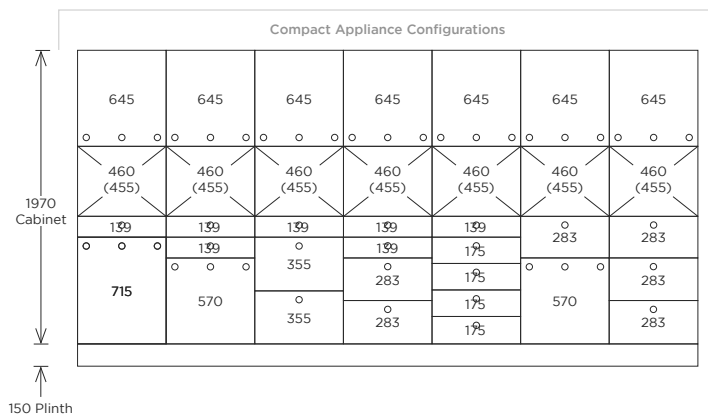
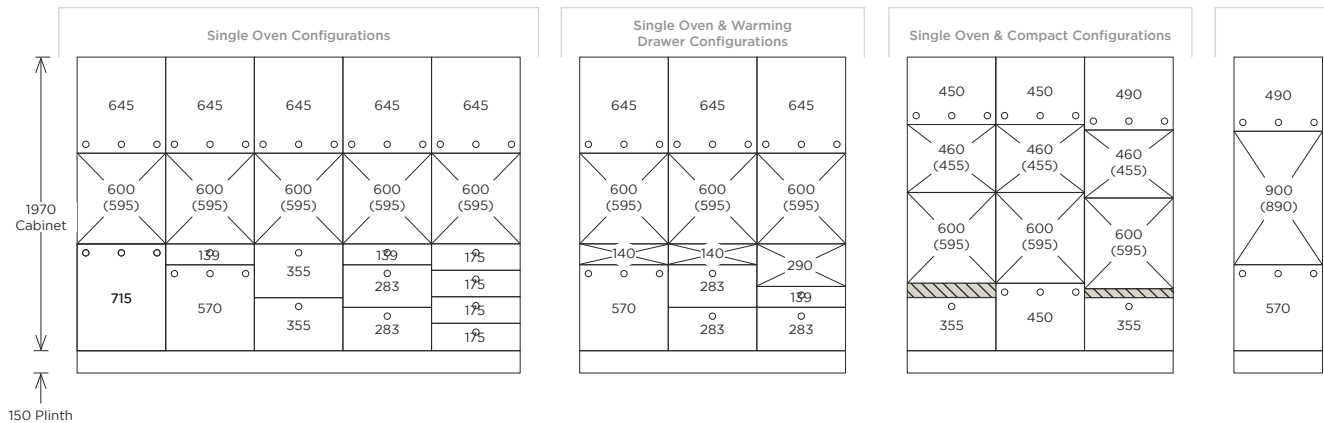

HANDLE LOCATION

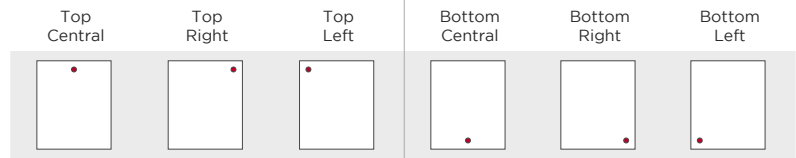

Recommended handle locations are illustrated on the doors below.

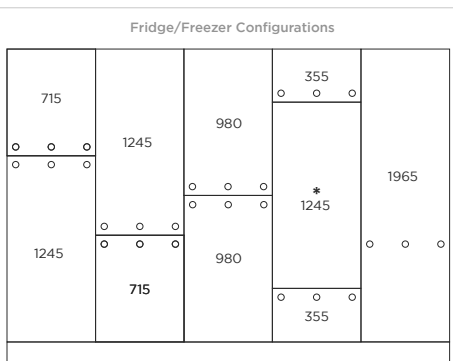
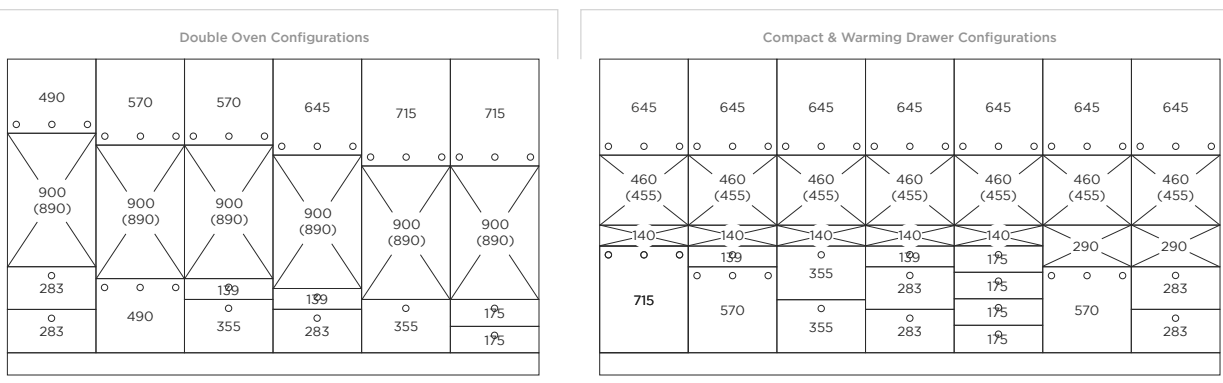
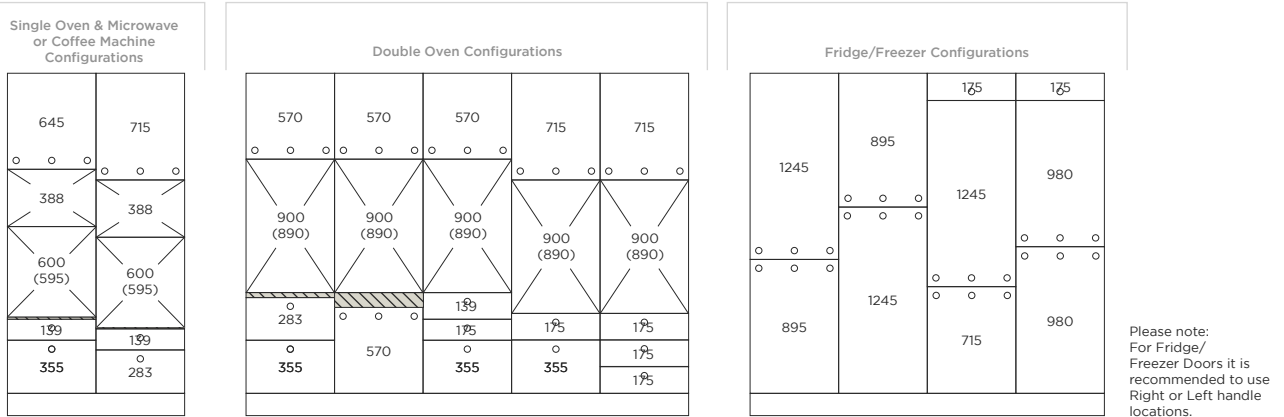
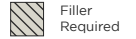

Please note: For Fridge/Freezer Doors it is recommended to use Right or Left handle locations.

Please note:

* Mounted handle recommended on configuration

Please note:

- Specialist appliance brands such as Miele, Sub Zero and Wolf adopt a different size matrix.
- If fillers must be used, typically a 139 x 597mm drawer front or 115 x 597mm oven trimmer are the most recommended products. Cut to size along the length to suit the void, and finish the raw edge using a PWS touch up kit.

Please note
*Not all handle locations available (please see 'Handle Location Guide' for more information)

PORTER EDGE



Door Drilling Service



Painted Finish



6 Year GUARANTEE

6 Year Guarantee

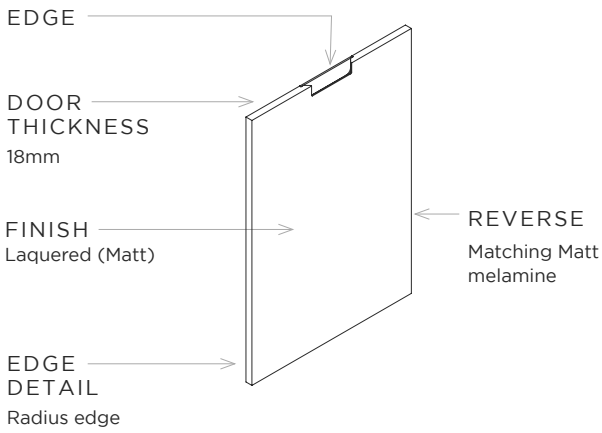

PORTER SPECIFICATION

DOOR FAMILY STYLE	Slab (over-painted)
DOOR THICKNESS	18mm
SUBSTRATE	MDF
FINISH	Painted (matt)
REVERSE	Matching matt melamine reverse (PtO - matching matt painted reverse)
CERTIFICATION	Fira Gold

HANDLE LOCATION

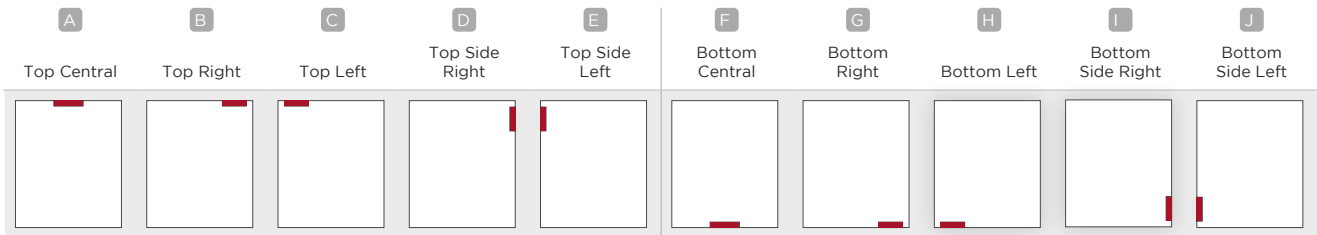

Note: This does not apply to 1965 Larder Doors. Please see page 37 for fixed handle height and lining through details.

HANDLE SPECIFICATION

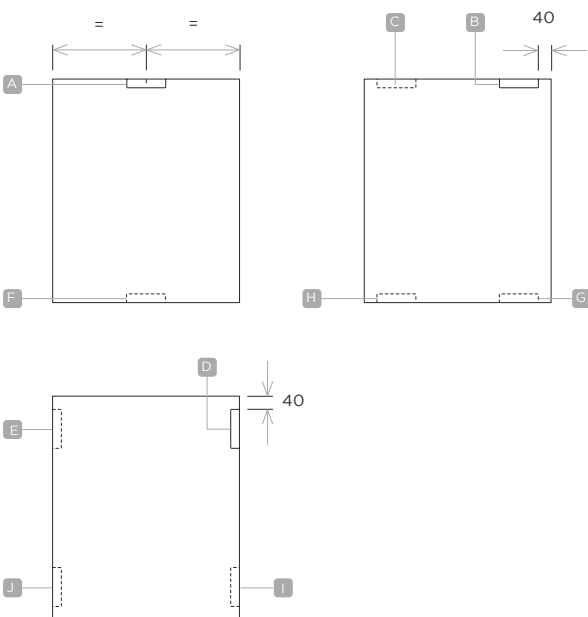

ROUTER SPECIFICATION

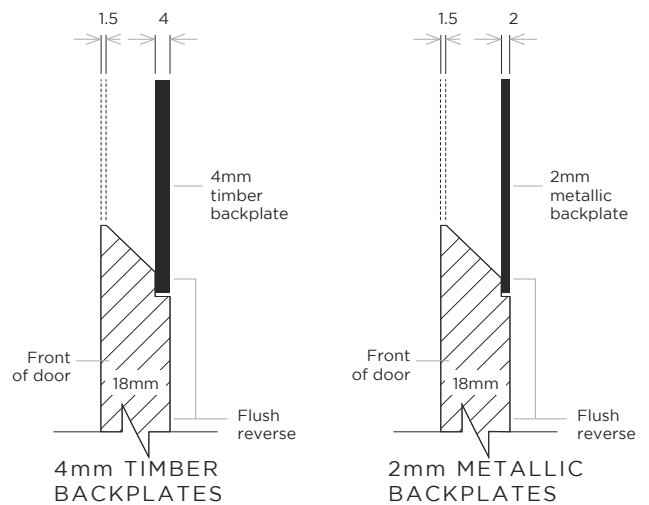

Note: For a flush reverse, doors are processed accordingly, to accommodate metallic and timber backplates.



Porter Edge Dust Grey shown with Matching backplate

PORTER EDGE

Code	(HxW)	Top Central	Bottom Central
Drawer fronts			
***85x597	85x597mm	✓	-
***85x797	85x797mm	✓	-
***85x997	85x997mm	✓	-
***143	139x297mm	✓	✓
***144	139x397mm	✓	✓
***139X447	139x447mm	✓	✓
***145	139x497mm	✓	✓
***146	139x597mm	✓	✓
***148	139x797mm	✓	✓
***149	139x897mm	✓	✓
***140	139x997mm	✓	✓
***175	175x497mm	✓	✓
***176	175x597mm	✓	✓

KEY INFORMATION

Frontal Prefix Codes

Stocked - **PSO**

Paint-to-order - **PXO**

X The following frontal sizes from stocked Porter are not available in Porter Edge

- ***116 115x597mm
- ***715X257 715x257mm, Base Filler Door for Small Curve Door
- ***CDS716 Small Curved Door, 715x300mm
- ***ICW600 Internal Curved Wall Door for 720x720x600x600mm cabinet
- ***ICB900 Internal Curved Base Door for 720x900x900mm cabinet



*Subject to capacity

		Top Central	Top Right	Top Left	Top Side Right	Top Side Left	Bottom Central	Bottom Right	Bottom Left	Bottom Side Right	Bottom Side Left
Drawer fronts											
***215x397	215x397mm	✓	-	-	-	-	✓	-	-	-	-
***215x497	215x497mm	✓	-	-	-	-	✓	-	-	-	-
***215x797	215x797mm	✓	-	-	-	-	✓	-	-	-	-
***215x997	215x997mm	✓	-	-	-	-	✓	-	-	-	-
***285	283x497mm	✓	-	-	-	-	✓	-	-	-	-
***286	283x597mm	✓	-	-	-	-	✓	-	-	-	-
***288	283x797mm	✓	-	-	-	-	✓	-	-	-	-
***289	283x897mm	✓	-	-	-	-	✓	-	-	-	-
***280	283x997mm	✓	-	-	-	-	✓	-	-	-	-
***353	355x297mm	✓	✓	✓	✓	✓	✓	✓	✓	✓	✓
***355	355x497mm	✓	✓	✓	✓	✓	✓	✓	✓	✓	✓
***356	355x597mm	✓	✓	✓	✓	✓	✓	✓	✓	✓	✓
***358	355x797mm	✓	-	-	-	-	✓	-	-	-	-
***359	355x897mm	✓	-	-	-	-	✓	-	-	-	-
***350	355x997mm	✓	-	-	-	-	✓	-	-	-	-
Doors											
***447x397	447x397mm	✓	✓	✓	✓	✓	✓	✓	✓	✓	✓
***447x447	447x447mm	✓	✓	✓	✓	✓	✓	✓	✓	✓	✓
***447x597	447x597mm	✓	✓	✓	✓	✓	✓	✓	✓	✓	✓
***456	450x597mm	✓	✓	✓	✓	✓	✓	✓	✓	✓	✓
***496	490x597mm	✓	✓	✓	✓	✓	✓	✓	✓	✓	✓
***573	570x297mm	✓	✓	✓	✓	✓	✓	✓	✓	✓	✓
***574	570x397mm	✓	✓	✓	✓	✓	✓	✓	✓	✓	✓
***570X447	570x447mm	✓	✓	✓	✓	✓	✓	✓	✓	✓	✓
***575	570x497mm	✓	✓	✓	✓	✓	✓	✓	✓	✓	✓
***576	570x597mm	✓	✓	✓	✓	✓	✓	✓	✓	✓	✓
***646	645x597mm, for use with single ovens	✓	✓	✓	✓	✓	✓	✓	✓	✓	✓

See
Fascia &
appliance
matrix
page 38-41

		Top Central	Top Right	Top Left	Top Side Right	Top Side Left	Bottom Central	Bottom Right	Bottom Left	Bottom Side Right	Bottom Side Left
Doors											
***715X147	715x147mm	-	-	-	✓	✓	-	-	-	✓	✓
***713	715x297mm	✓	✓	✓	✓	✓	✓	✓	✓	✓	✓
***715X347	715x347mm	✓	✓	✓	✓	✓	✓	✓	✓	✓	✓
***714	715x397mm	✓	✓	✓	✓	✓	✓	✓	✓	✓	✓
***715X447	715x447mm	✓	✓	✓	✓	✓	✓	✓	✓	✓	✓
***715	715x497mm	✓	✓	✓	✓	✓	✓	✓	✓	✓	✓
***715x547	715x547mm	✓	✓	✓	✓	✓	✓	✓	✓	✓	✓
***716	715x597mm	✓	✓	✓	✓	✓	✓	✓	✓	✓	✓
***893	895x297mm	✓	✓	✓	✓	✓	✓	✓	✓	✓	✓
***894	895x397mm	✓	✓	✓	✓	✓	✓	✓	✓	✓	✓
***895X447	895x447mm	✓	✓	✓	✓	✓	✓	✓	✓	✓	✓
***895	895x497mm	✓	✓	✓	✓	✓	✓	✓	✓	✓	✓
***896	895x597mm	✓	✓	✓	✓	✓	✓	✓	✓	✓	✓
***986	980x597mm	✓	✓	✓	✓	✓	✓	✓	✓	✓	✓

Larder doors		Top Central	Top Right	Top Left	Top Side Right	Top Side Left	Bottom Central	Bottom Right	Bottom Left	Bottom Side Right	Bottom Side Left
***123	1245x297mm	✓	✓	✓	✓	✓	✓	✓	✓	✓	✓
***124	1245x397mm	✓	✓	✓	✓	✓	✓	✓	✓	✓	✓
***125	1245x497mm	✓	✓	✓	✓	✓	✓	✓	✓	✓	✓
***126	1245x597mm	✓	✓	✓	✓	✓	✓	✓	✓	✓	✓

Fixed Right Fixed Left

Note: • 1965 Larder Doors have a fixed handle height of 819mm. This lines through with adjacent 1245mm door configurations (70/30 F/F).
• Larder doors are handed

819 Fixed

Tall larder doors

***193	1965x297mm	✓	✓
***195	1965x497mm	✓	✓
***196	1965x597mm	✓	✓

Fixed Right Fixed Left

Note: • Robe doors are handed

976 Fixed

Robe doors

***2154x397	2154x397mm	✓	✓
***2154x447	2154x447mm	✓	✓
***2154x497	2154x497mm	✓	✓

		Top Central	Bottom Central
Glazed doors			
***715FS	715x497mm, clear glazed	✓	✓

		Top Central	Top Side Right	Top Side Left	Bottom Central	Bottom Side Right	Bottom Side Left
Corner doors							
***WCDS	715x277	-	-	-	✓	✓	✓
***CDS	715x315	✓	✓	✓	-	-	-

Note: Corner doors come as a pair. Handle features on one door only.

PORTER EDGE

KITCHEN FASCIA MATRIX FOR LAY-ON DOORS

This matrix can be referred to when planning a design in Porter Edge. The matrix illustrates recommended configurations and Edge handle locations, based on stocked sizes from the Porter range. Please reference page 36 for 'Handle Location Guide'.

TALL HEIGHT INSTALLATION

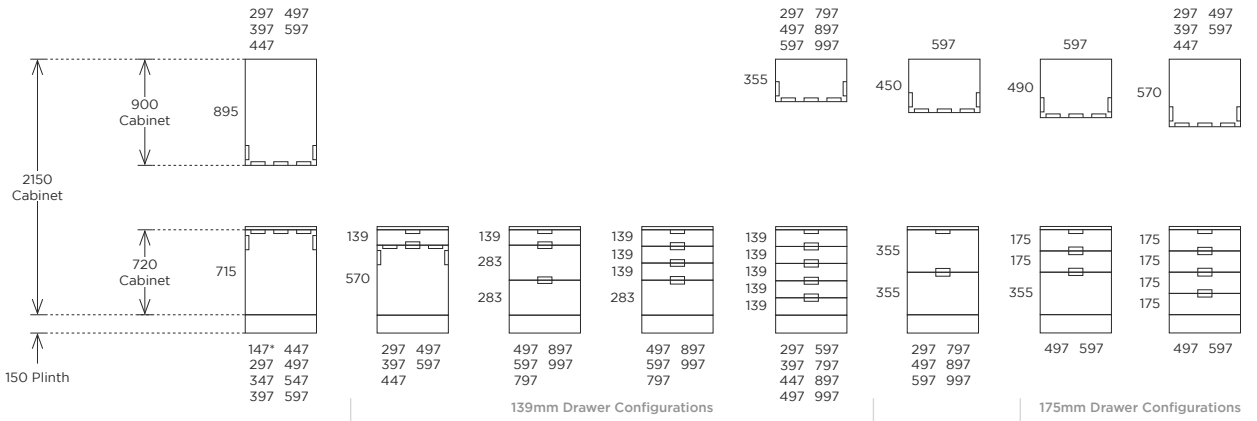

MEDIUM HEIGHT INSTALLATION

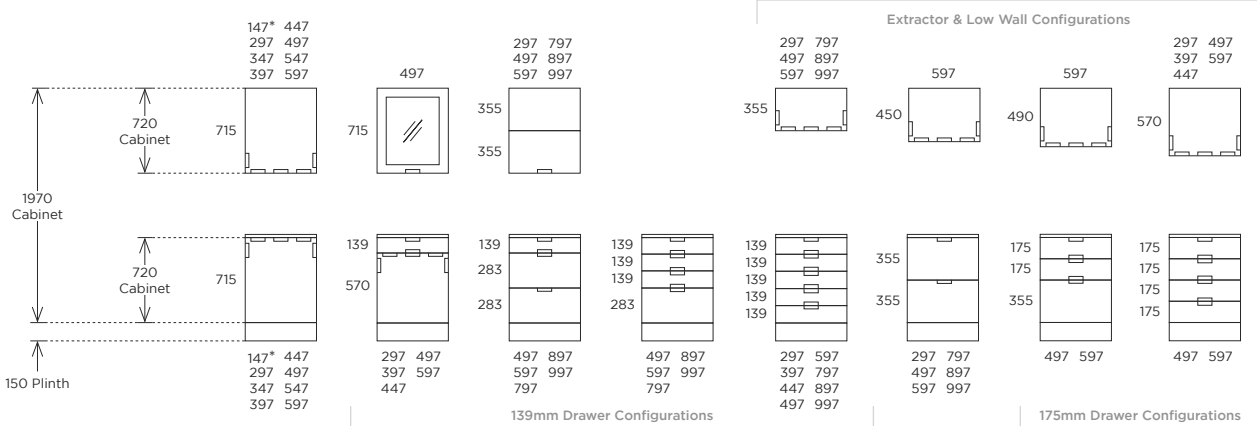

LOW HEIGHT INSTALLATION

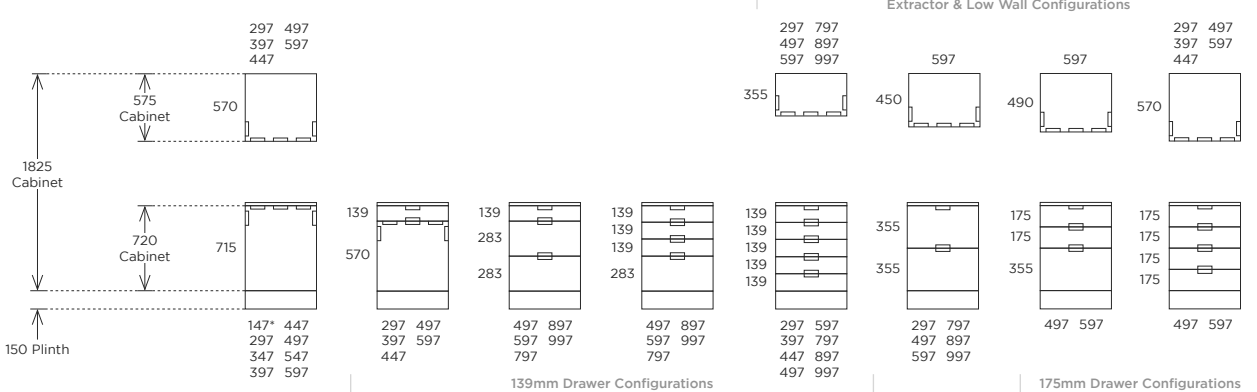

HANDLE LOCATION

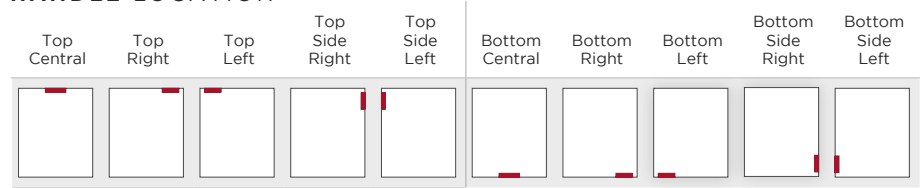

Recommended handle locations are illustrated on the doors below.

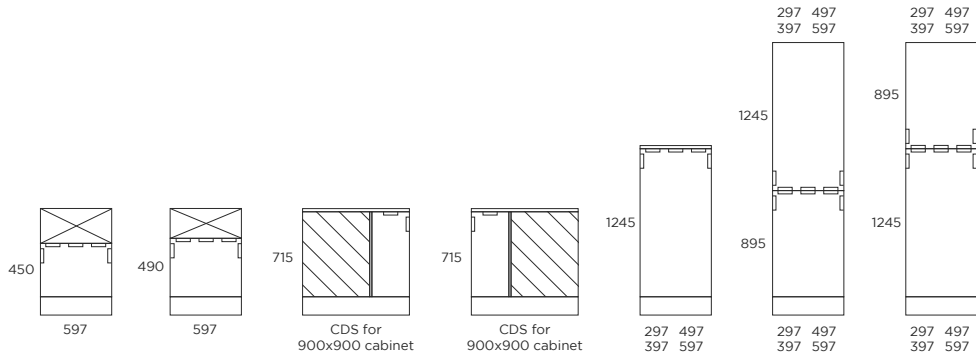

Ceramic Sink Configurations

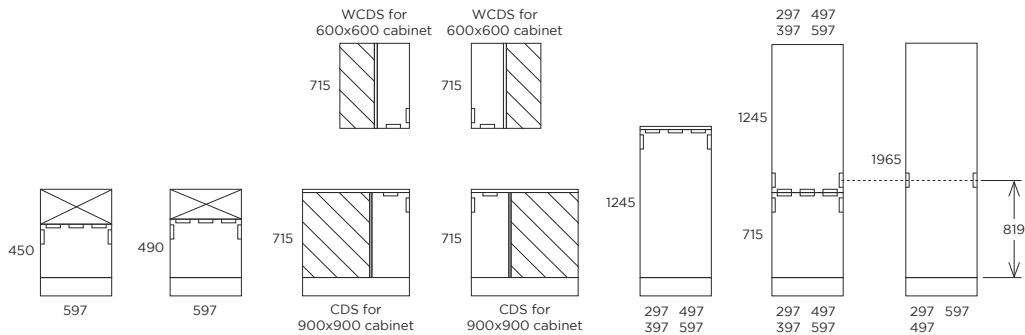

1965 Larder Doors have a fixed handle height of 819mm. This lines through with adjacent 1245mm door configurations (70/30 F/F).

Ceramic Sink Configurations

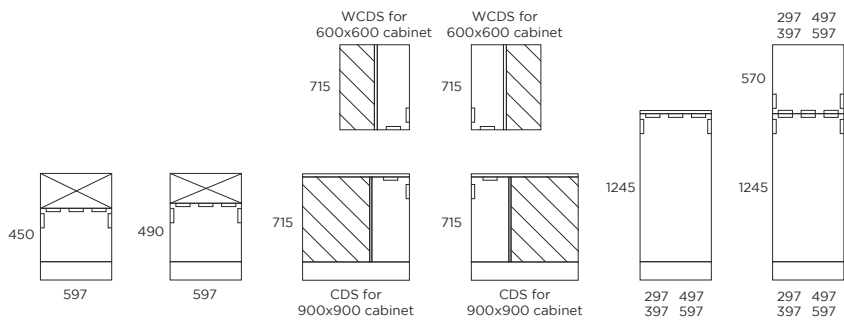

Ceramic Sink Configurations

Please note
*Not all handle locations available (please see 'Handle Location Guide' for more information)

PORTER EDGE

KITCHEN APPLIANCE MATRIX FOR LAY-ON DOORS

This matrix can be referred to when planning built-in appliance housings in Porter Edge. The matrix illustrates industry standard configurations and Edge handle locations, based on stocked sizes from the Porter range. Whilst the majority of these configurations eradicates the need for fillers, there are a few instances where a filler is required (see in matrix).

Please note: Aperture sizes shown with the actual appliance size shown below in brackets.

TALL HEIGHT INSTALLATION

To be used with 600mm wide appliances

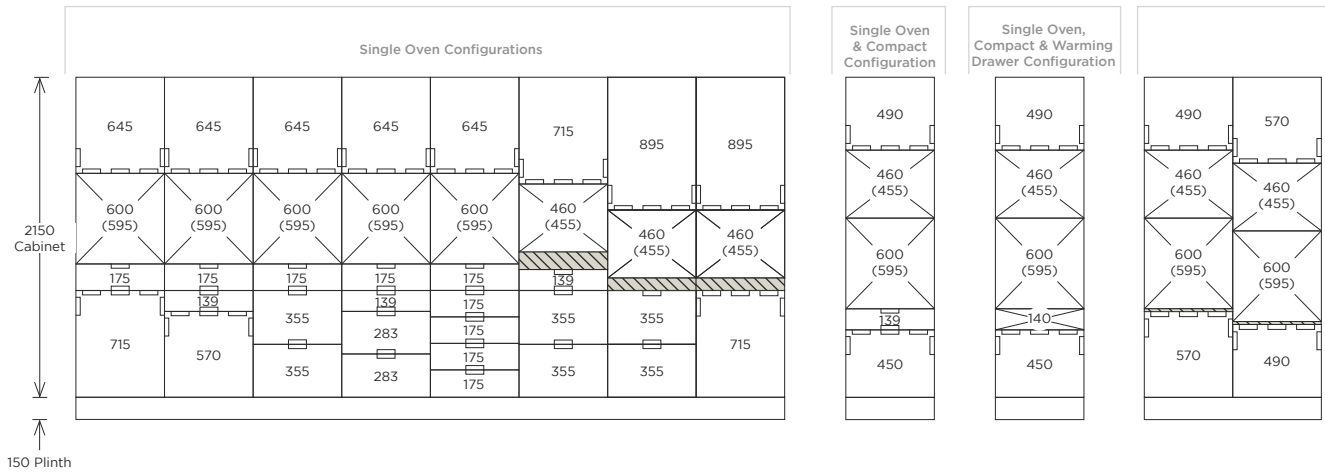

MEDIUM HEIGHT INSTALLATION

To be used with 600mm wide appliances

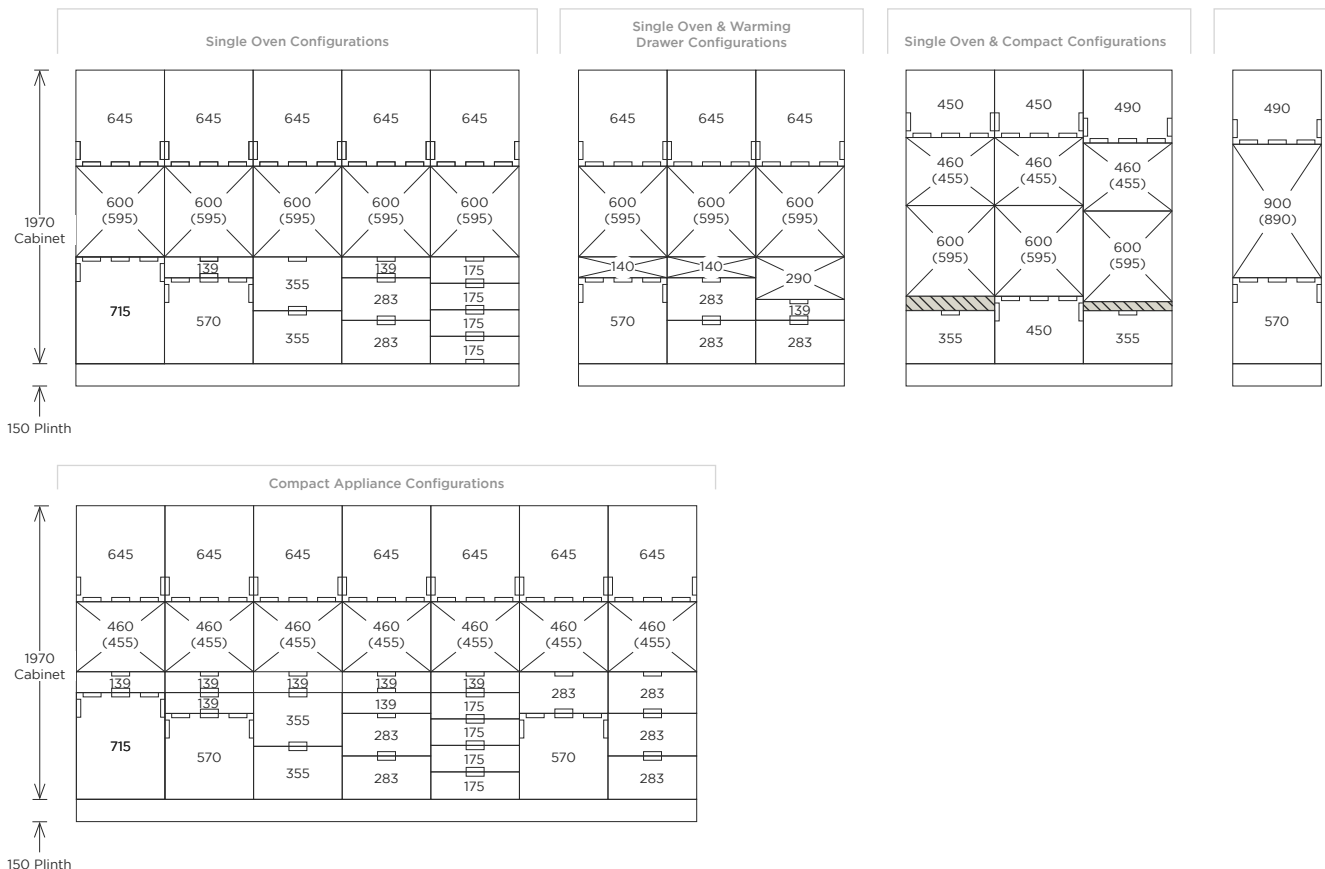

HANDLE LOCATION

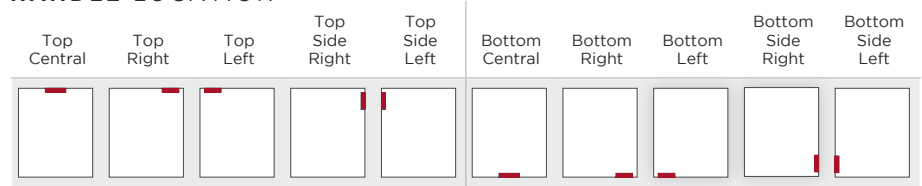

Recommended handle locations are illustrated on the doors below.

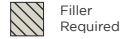

Single Oven & Microwave or Coffee Machine Configurations

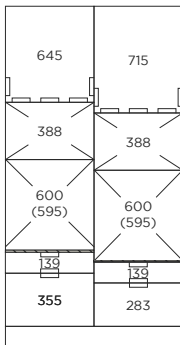

Double Oven Configurations

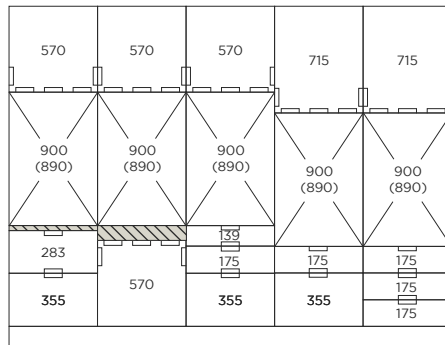

Fridge/Freezer Configurations

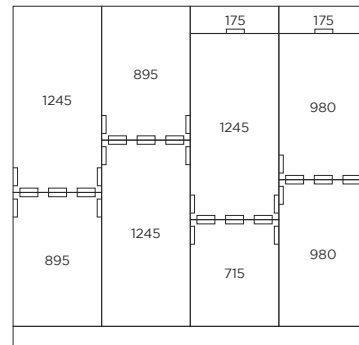

Please note:
For Fridge/
Freezer Doors it is
recommended to use
Right or Left handle
locations.

Double Oven Configurations

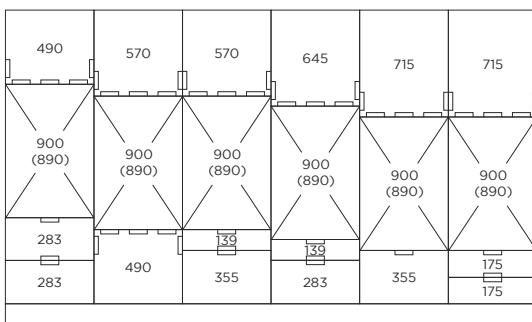

Compact & Warming Drawer Configurations

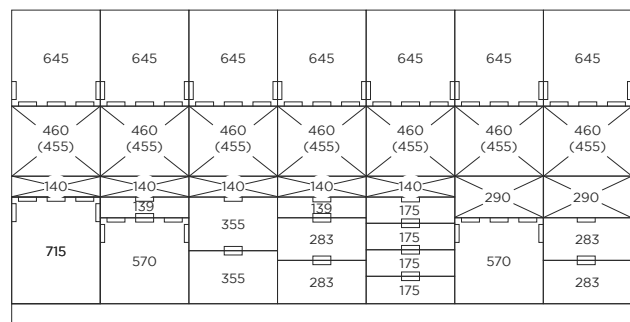

Fridge/Freezer Configurations

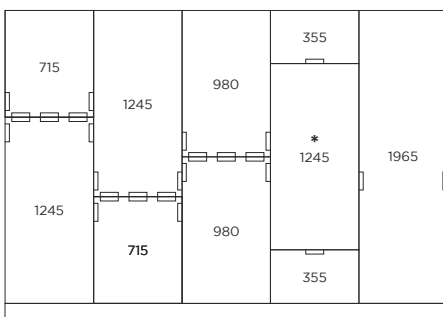

Please note: For Fridge/Freezer Doors it is recommended to use Right or Left handle locations.

Please note:

* Mounted handle recommended on configuration

Please note:

- Specialist appliance brands such as Miele, Sub Zero and Wolf adopt a different size matrix.
- If fillers must be used, typically a 139 x 597mm drawer front or 115 x 597mm oven trimmer are the most recommended products. Cut to size along the length to suit the void, and finish the raw edge using a PWS touch up kit.

Please note

*Not all handle locations available (please see 'Handle Location Guide' for more information)

PORTER CHANNEL

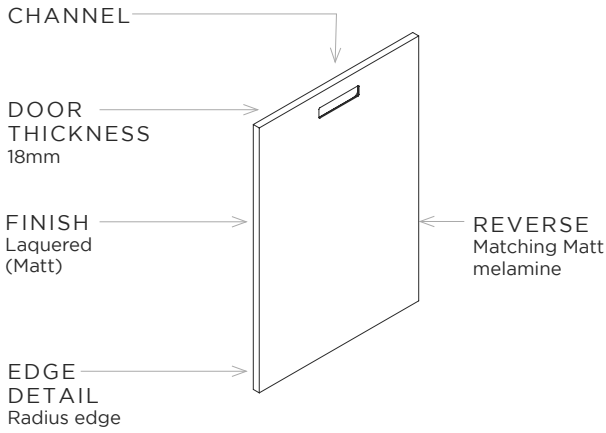

PORTER SPECIFICATION

DOOR FAMILY STYLE	Slab (over-painted)
DOOR THICKNESS	18mm
SUBSTRATE	MDF
FINISH	Painted (matt)
REVERSE	Matching matt melamine reverse (PtO - matching matt painted reverse)
CERTIFICATION	Fira Gold

HANDLE LOCATION

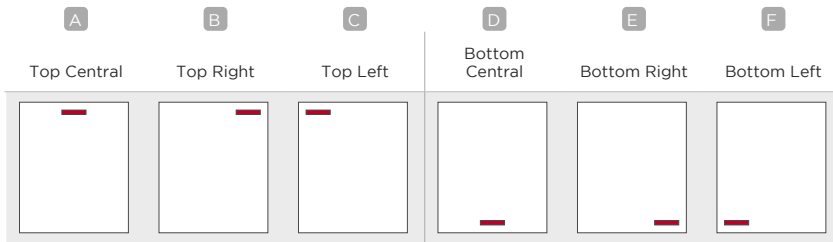

Note: This does not apply to 1965 Larder Doors. Please see page 45 for fixed handle height and lining through details.

HANDLE SPECIFICATION

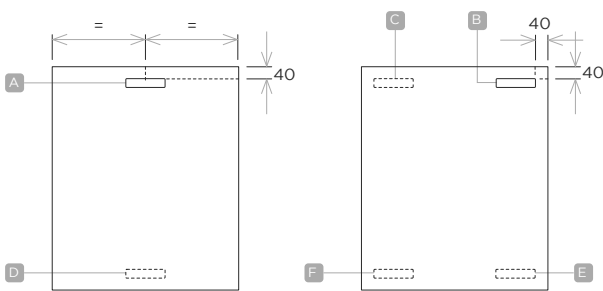

ROUTER SPECIFICATION

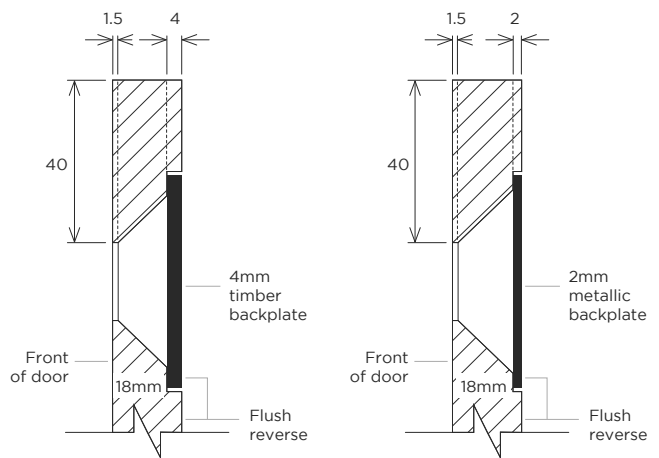

4mm TIMBER BACKPLATES

2mm METALLIC BACKPLATES

Note: For a flush reverse doors are processed accordingly, to accommodate metallic and timber backplates.



Porter Channel Cope Green shown with Aged Brass backplate

PORTER CHANNEL

Code	(HxW)	Top Central
Drawer fronts		
***143	139x297mm	✓
***144	139x397mm	✓
***139X447	139x447mm	✓
***145	139x497mm	✓
***146	139x597mm	✓
***148	139x797mm	✓
***149	139x897mm	✓
***140	139x997mm	✓
***175	175x497mm	✓
***176	175x597mm	✓

KEY INFORMATION

Frontal Prefix Codes
 Stocked - **PSO**
 Paint-to-order - **PXO**

*Subject to capacity

X The following frontal sizes from stocked Porter are not available in Porter Channel

- ***85x597 85x597mm
- ***85x797 85x797mm
- ***85x997 85x997mm
- ***116 115x597mm
- ***715X147 715x147mm
- ***715X257 715x257mm, Base Filler Door for Small Curve Door
- ***CDS716 Small Curved Door, 715x300mm
- ***ICW600 Internal Curved Wall Door for 720x720x600x600mm cabinet
- ***ICB900 Internal Curved Base Door for 720x900x900mm cabinet
- ***715FS 715x497mm, Clear Glazed

	Top Central	Top Right	Top Left	Bottom Central	Bottom Right	Bottom Left
Drawer fronts						
***215x397	✓	-	-	✓	-	-
***215x497	✓	-	-	✓	-	-
***215x797	✓	-	-	✓	-	-
***215x997	✓	-	-	✓	-	-
***285	✓	-	-	✓	-	-
***286	✓	-	-	✓	-	-
***288	✓	-	-	✓	-	-
***289	✓	-	-	✓	-	-
***280	✓	-	-	✓	-	-
***353	✓	✓	✓	✓	✓	✓
***355	✓	✓	✓	✓	✓	✓
***356	✓	✓	✓	✓	✓	✓
***358	✓	-	-	✓	-	-
***359	✓	-	-	✓	-	-
***350	✓	-	-	✓	-	-
Doors						
***447x397	✓	✓	✓	✓	✓	✓
***447x447	✓	✓	✓	✓	✓	✓
***447x597	✓	✓	✓	✓	✓	✓
***456	✓	✓	✓	✓	✓	✓
***496	✓	✓	✓	✓	✓	✓
***573	✓	✓	✓	✓	✓	✓
***574	✓	✓	✓	✓	✓	✓
***570X447	✓	✓	✓	✓	✓	✓
***575	✓	✓	✓	✓	✓	✓
***576	✓	✓	✓	✓	✓	✓
***646	✓	✓	✓	✓	✓	✓

		Top Central	Top Right	Top Left	Bottom Central	Bottom Right	Bottom Left
Doors							
***713	715x297mm	✓	✓	✓	✓	✓	✓
***715X347	715x347mm	✓	✓	✓	✓	✓	✓
***714	715x397mm	✓	✓	✓	✓	✓	✓
***715X447	715x447mm	✓	✓	✓	✓	✓	✓
***715	715x497mm	✓	✓	✓	✓	✓	✓
***715x547	715x547mm	✓	✓	✓	✓	✓	✓
***716	715x597mm	✓	✓	✓	✓	✓	✓
***893	895x297mm	✓	✓	✓	✓	✓	✓
***894	895x397mm	✓	✓	✓	✓	✓	✓
***895X447	895x447mm	✓	✓	✓	✓	✓	✓
***895	895x497mm	✓	✓	✓	✓	✓	✓
***896	895x597mm	✓	✓	✓	✓	✓	✓
***986	980x597mm	✓	✓	✓	✓	✓	✓
Larder doors							
***123	1245x297mm	✓	✓	✓	✓	✓	✓
***124	1245x397mm	✓	✓	✓	✓	✓	✓
***125	1245x497mm	✓	✓	✓	✓	✓	✓
***126	1245x597mm	✓	✓	✓	✓	✓	✓

		Fixed Central	Fixed Right	Fixed Left
<p>Note: • 1965mm Larder doors have a fixed handle position to line through with 715 base doors. • Larder doors are handed</p>				
Tall larder doors				
***193	1965x297mm	✓	✓	✓
***195	1965x497mm	✓	✓	✓
***196	1965x597mm	✓	✓	✓

		Fixed Right	Fixed Left
<p>Note: • Robe doors are handed</p>			
Robe doors			
***2154x397	2154x397mm	✓	✓
***2154x447	2154x447mm	✓	✓
***2154x497	2154x497mm	✓	✓

		Top Central	Top Right	Top Left	Bottom Central	Bottom Right	Bottom Left
Corner doors							
***WCDS	715x315	-	-	-	✓	✓	✓
***CDS	715x277	✓	✓	✓	-	-	-

Note: Corner doors come as a pair. Handle features on one door only.

PORTER CHANNEL

KITCHEN FASCIA MATRIX FOR LAY-ON DOORS

This matrix can be referred to when planning a design in Porter Channel. The matrix illustrates recommended configurations and Channel handle locations, based on stocked sizes from the Porter range. Please reference page 44-45 for 'Handle Location Guide'.

TALL HEIGHT INSTALLATION

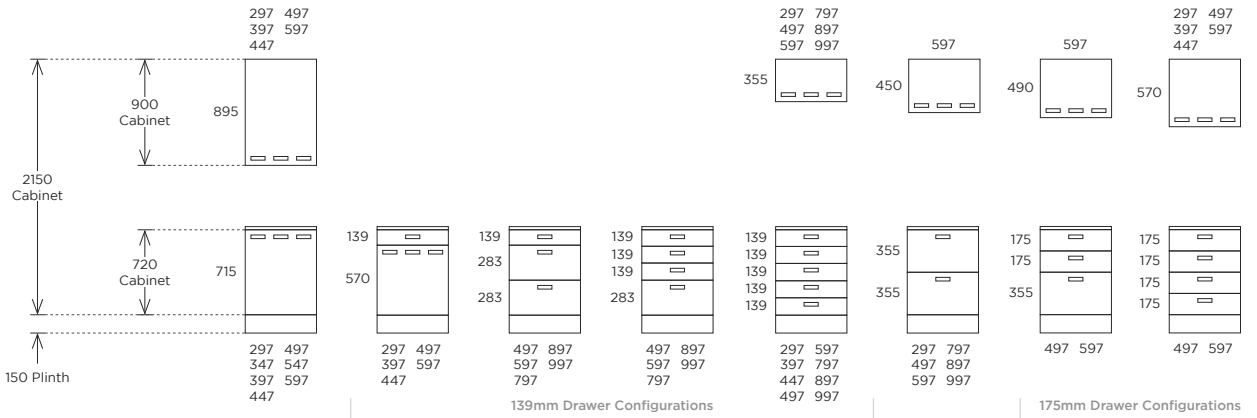

MEDIUM HEIGHT INSTALLATION

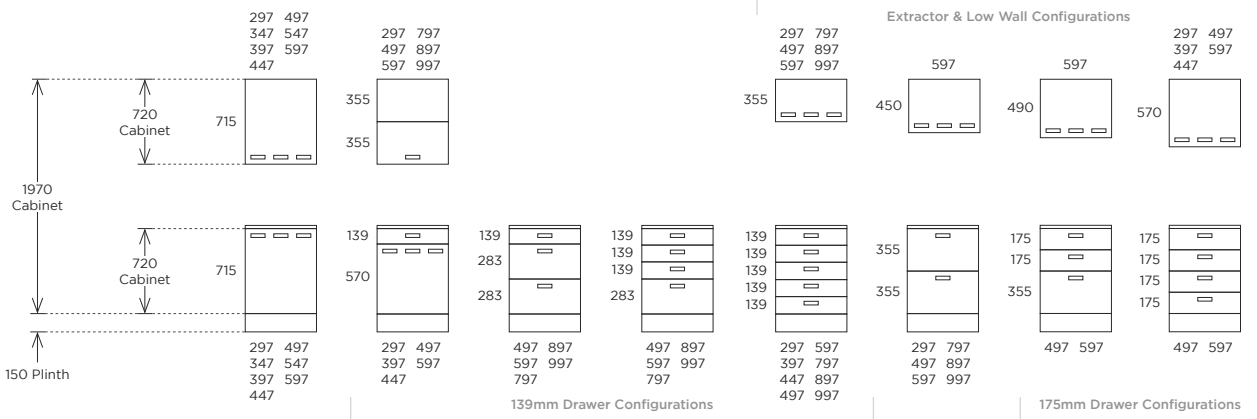

LOW HEIGHT INSTALLATION

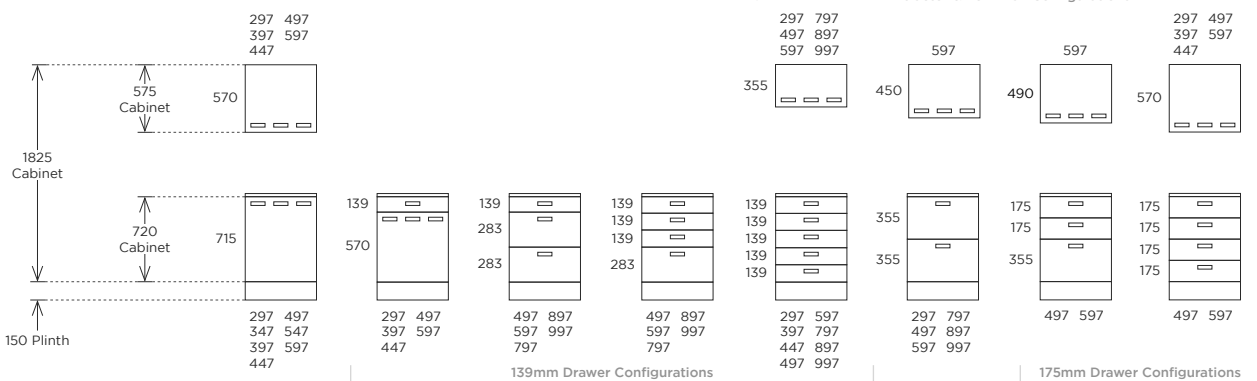

PORTER CHANNEL

KITCHEN APPLIANCE MATRIX FOR LAY-ON DOORS

This matrix can be referred to when planning built-in appliance housings in Porter Channel. The matrix illustrates industry standard configurations and Channel handle locations, based on stocked sizes from the Porter range. Whilst the majority of these configurations eradicates the need for fillers, there are a few instances where a filler is required (see in matrix).

Please note: Aperture sizes shown with the actual appliance size shown below in brackets.

TALL HEIGHT INSTALLATION

To be used with 600mm wide appliances

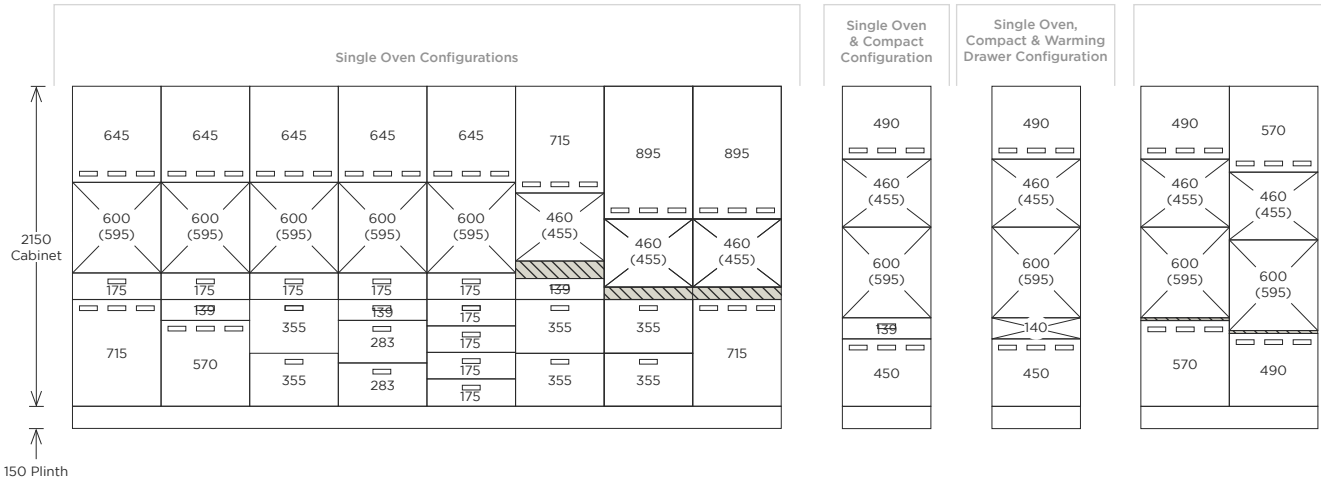

MEDIUM HEIGHT INSTALLATION

To be used with 600mm wide appliances

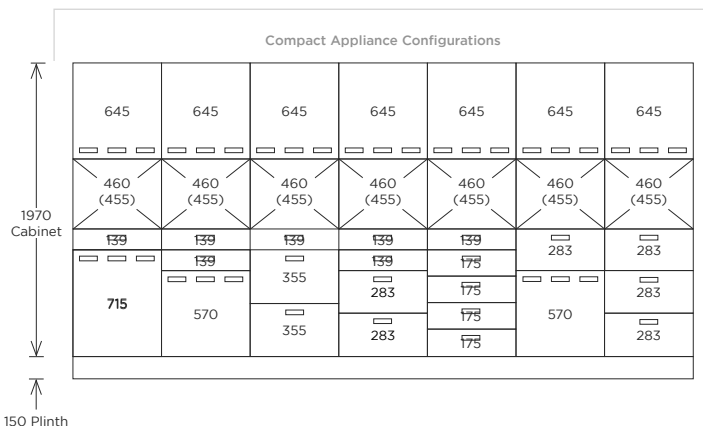
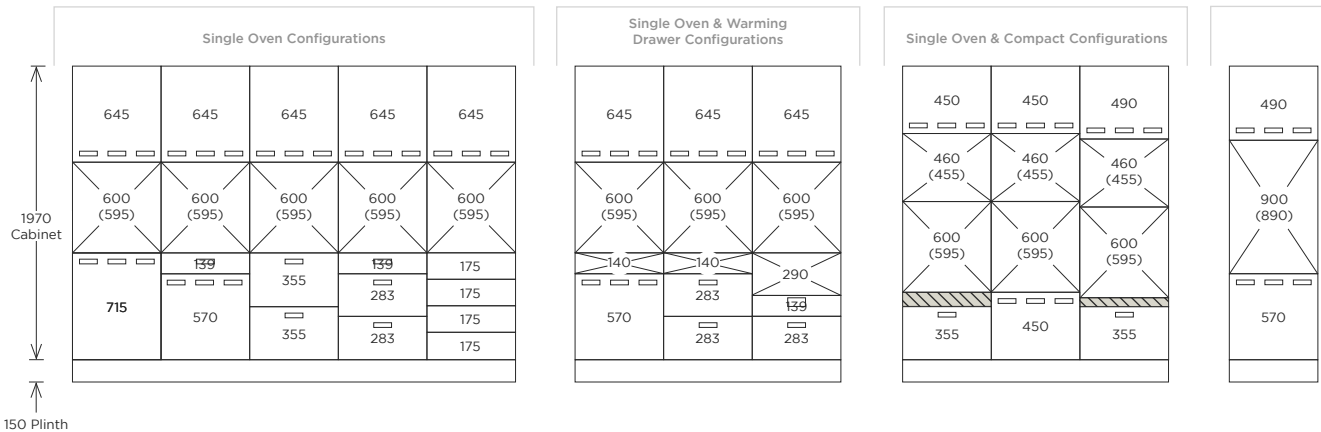

HANDLE LOCATION

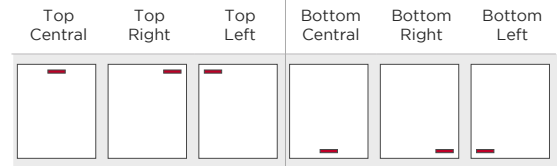

Recommended handle locations are illustrated on the doors below.

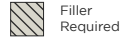

Single Oven & Microwave or Coffee Machine Configurations

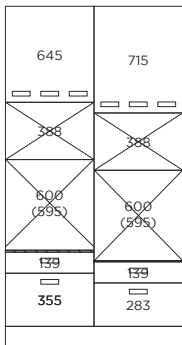

Double Oven Configurations

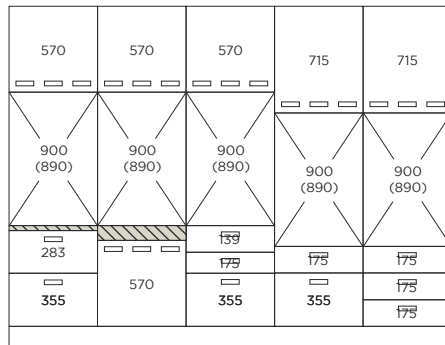

Fridge/Freezer Configurations

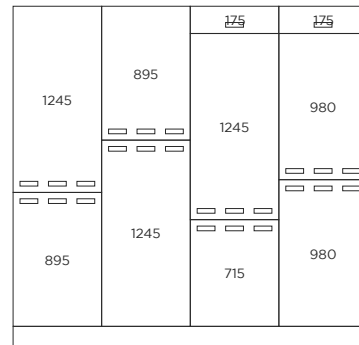

Please note:
For Fridge/Freezer Doors it is recommended to use Right or Left handle locations.

Double Oven Configurations

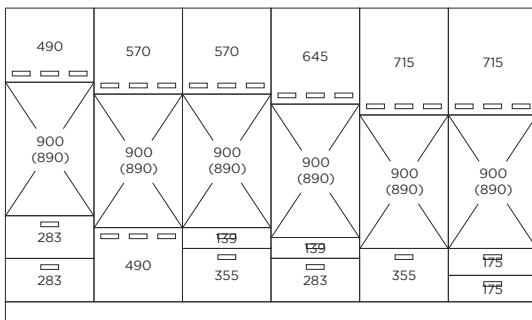

Compact & Warming Drawer Configurations

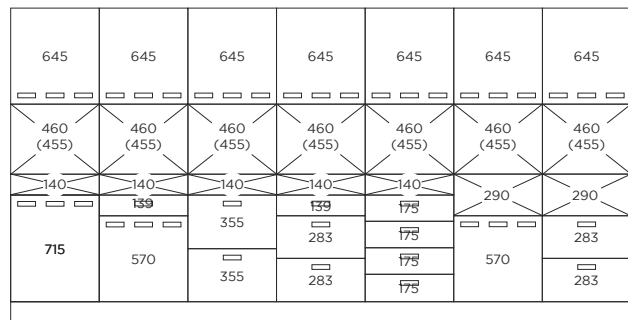

Fridge/Freezer Configurations

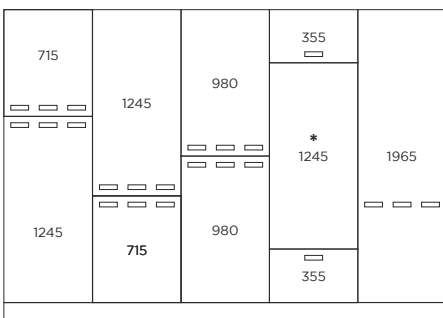

Please note: For Fridge/Freezer Doors it is recommended to use Right or Left handle locations.

Please note:
* Mounted handle recommended on configuration

Please note:
- Specialist appliance brands such as Miele, Sub Zero and Wolf adopt a different size matrix.
- If fillers must be used, typically a 139 x 597mm drawer front or 115 x 597mm oven trimmer are the most recommended products. Cut to size along the length to suit the void, and finish the raw edge using a PWS touch up kit.

Please note
*Not all handle locations available (please see 'Handle Location Guide' for more information)

PORTER EXTENDED CHANNEL

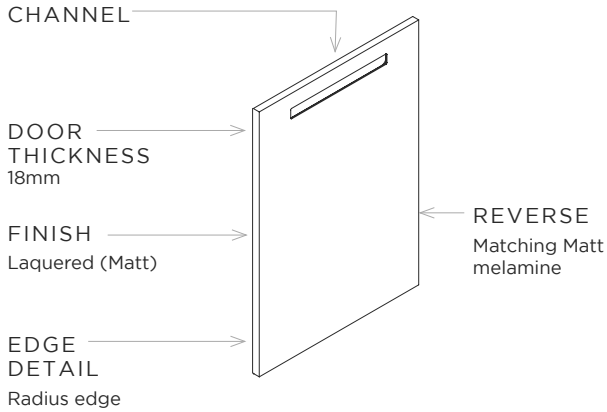

PORTER SPECIFICATION

DOOR FAMILY STYLE	Slab (over-painted)
DOOR THICKNESS	18mm
SUBSTRATE	MDF
FINISH	Painted (matt)
REVERSE	Matching matt melamine reverse (PtO - matching matt painted reverse)
CERTIFICATION	Fira Gold

HANDLE LOCATION

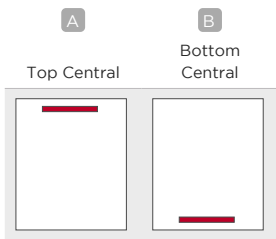

Note: This does not apply to 1965 Larder Doors.

HANDLE SPECIFICATION

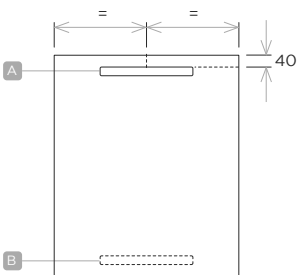

ROUTER SPECIFICATION

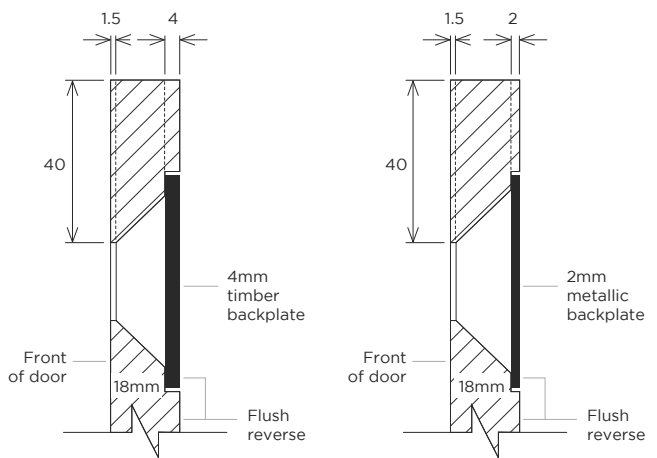

4mm TIMBER BACKPLATES

2mm METALLIC BACKPLATES

Note: For a flush reverse doors are processed accordingly, to accommodate metallic and timber backplates.





Porter Extended Channel Carbon shown with Walnut backplates



PORTER EXTENDED CHANNEL



Note: Fascia fronts W397+ are compatible with Extended Channel.

Code	(HxW)	Top Central
Drawer fronts 		
***139X447	139x447mm	✓
***145	139x497mm	✓
***146	139x597mm	✓
***148	139x797mm	✓
***149	139x897mm	✓
***140	139x997mm	✓
***175	175x497mm	✓
***176	175x597mm	✓

		Top Central	Bottom Central
Drawer fronts  			
***215x497	215x497mm	✓	✓
***215x797	215x797mm	✓	✓
***215x997	215x997mm	✓	✓
***285	283x497mm	✓	✓
***286	283x597mm	✓	✓
***288	283x797mm	✓	✓
***289	283x897mm	✓	✓
***280	283x997mm	✓	✓
***355	355x497mm	✓	✓
***356	355x597mm	✓	✓
***358	355x797mm	✓	✓
***359	355x897mm	✓	✓
***350	355x997mm	✓	✓

		Top Central	Bottom Central
Doors  			
***447x447	447x447mm	✓	✓
***447x597	447x597mm	✓	✓
***456	450x597mm	✓	✓
***496	490x597mm	✓	✓
***570X447	570x447mm	✓	✓
***575	570x497mm	✓	✓
***576	570x597mm	✓	✓
***646	645x597mm, for use with single ovens	✓	✓

KEY INFORMATION

Frontal Prefix Codes

Stocked - **PSO**



Paint-to-order - **PXO**

X The following frontal sizes from stocked Porter are not available in Porter Extended Channel

- ***85x597 85x597mm
- ***85x797 85x797mm
- ***85x997 85x997mm
- ***116 115x597mm
- ***143 139x297mm
- ***144 139x397mm
- ***215x397 215x397mm
- ***353 355x297mm
- ***447x397 447x397mm
- ***573 570x297mm
- ***574 570x397mm
- ***715X147 715x147mm
- ***715X257 715x257mm, Base Filler Door for Small Curve Door
- ***713 715x297mm
- ***714 715x397mm
- ***715X347 715x347mm
- ***893 895x297mm
- ***894 895x397mm
- ***123 1245x297mm
- ***124 1245x397mm
- ***WCDS 715x277x18mm, Wall Corner Door Solution (pair)
- ***CDS 715x315x18mm, Corner Door Solution (pair)
- ***CDS716 Small Curved Door, 715x300mm
- ***ICW600 Internal Curved Wall Door for 720x720x600x600mm cabinet
- ***ICB900 Internal Curved Base Door for 720x900x900mm cabinet
- ***715FS 715x497mm, Clear Glazed



*Subject to capacity

		Top Central	Bottom Central
Doors  			
***715X447	715x447mm	✓	✓
***715	715x497mm	✓	✓
***715x547	715x547mm	✓	✓
***716	715x597mm	✓	✓
***895X447	895x447mm	✓	✓
***895	895x497mm	✓	✓
***896	895x597mm	✓	✓
***986	980x597mm	✓	✓

		Top Central	Bottom Central
Larder doors			
***125	1245x497mm	✓	✓
***126	1245x597mm	✓	✓

		Fixed Central	Fixed Right Vertical	Fixed Left Vertical
Note: See page 135 for lining details				
	661 Fixed			794.5 Fixed
Tall larder doors				
***193	1965x297mm	-	✓	✓
***195	1965x497mm	✓	✓	✓
***196	1965x597mm	✓	✓	✓

		Fixed Central	Fixed Right Vertical	Fixed Left Vertical
Note: • Robe doors are handed				
	976 Fixed			976 Fixed
Robe doors				
***2154x397	2154x397mm	-	✓	✓
***2154x447	2154x447mm	✓	✓	✓
***2154x497	2154x497mm	✓	✓	✓

Corner Doors

Note: Corner doors are not compatible with Porter Extended Channel, for this reason, we recommend using Porter Channel. Please see the Porter Channel handle location guide spread for more information on this range.

PORTER EXTENDED CHANNEL

KITCHEN FASCIA MATRIX FOR LAY-ON DOORS

This matrix can be referred to when planning a design in Porter Extended Channel. The matrix illustrates recommended configurations and Extended Channel handle locations, based on stocked sizes from the Porter range.

TALL HEIGHT INSTALLATION

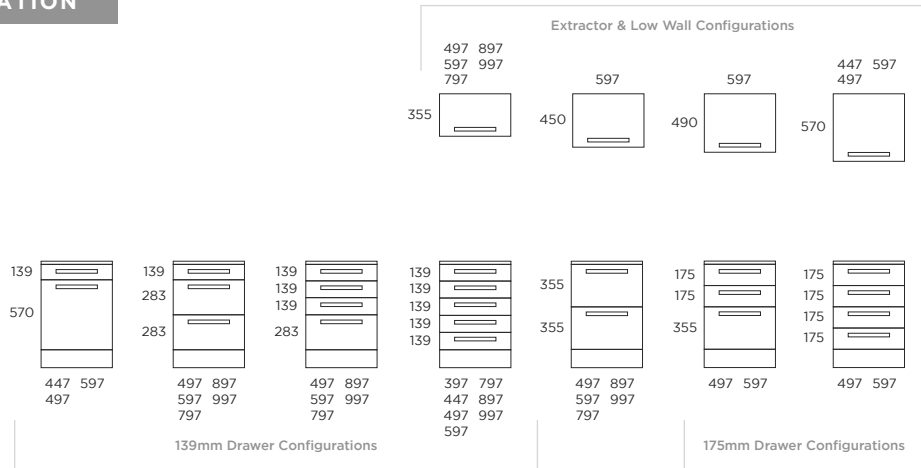
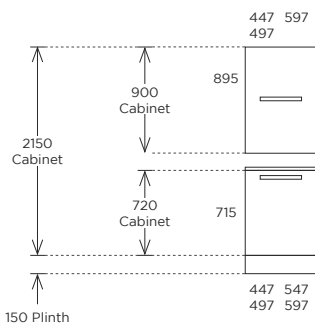

MEDIUM HEIGHT INSTALLATION

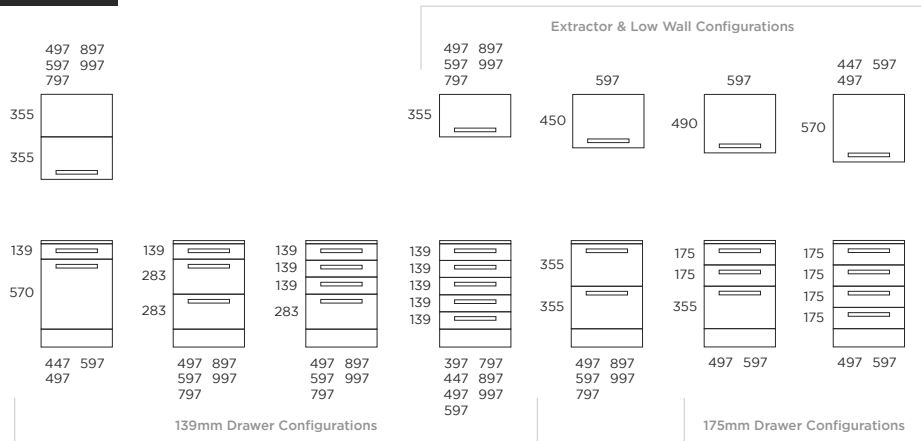
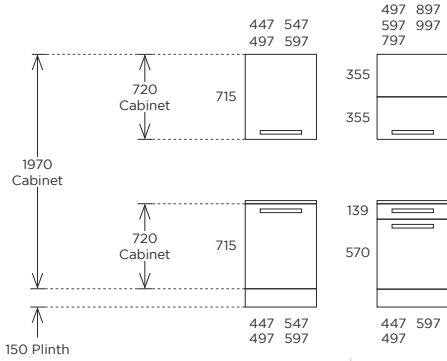

LOW HEIGHT INSTALLATION

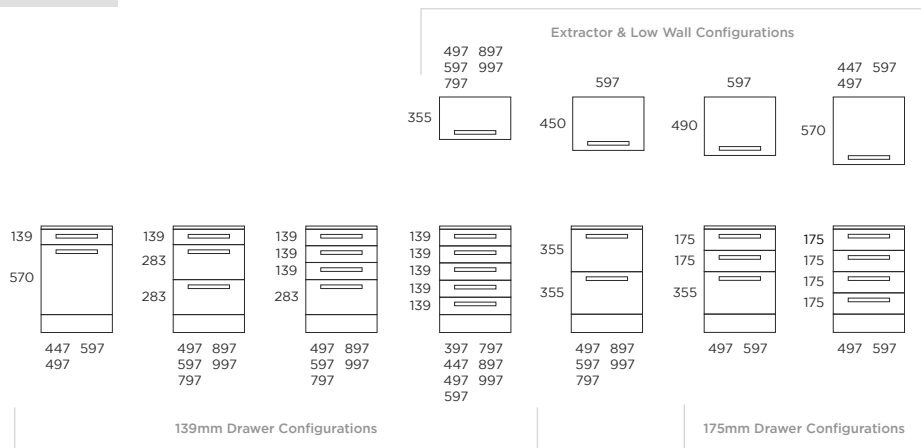
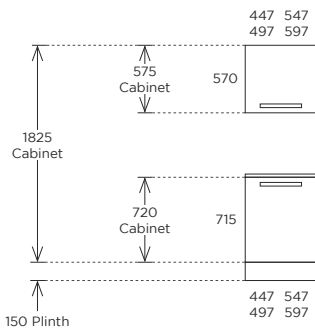

HANDLE LOCATION

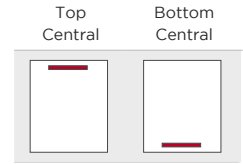

Recommended handle locations are illustrated on the doors below.

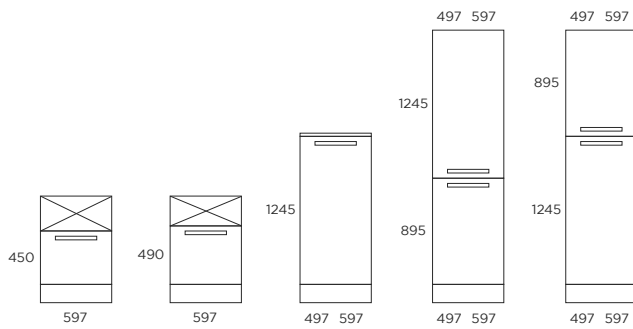

Ceramic Sink Configurations

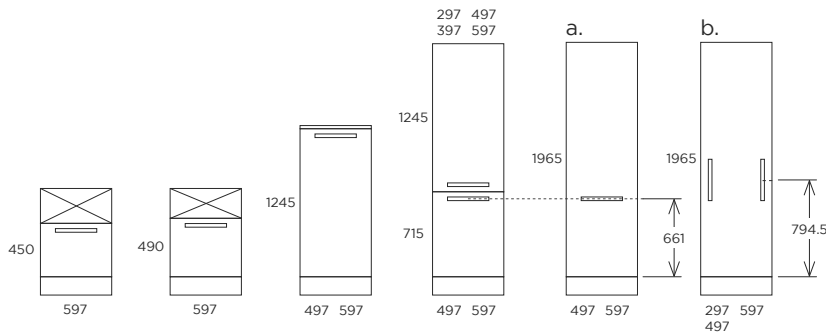

a. 1965 Larder Doors with a horizontal handle, have a fixed handle height of 661mm. This lines through with adjacent 715 base configurations.

b. 1965 Larder Doors with a vertical handle, have a fixed handle height of 794.5mm. See lining through details on page 135.

Ceramic Sink Configurations

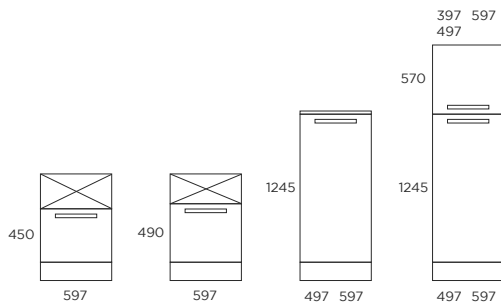

Ceramic Sink Configurations

Please note
*Not all handle locations available (please see 'Handle Location Guide' for more information)

PORTER EXTENDED CHANNEL

KITCHEN APPLIANCE MATRIX FOR LAY-ON DOORS

This matrix can be referred to when planning built-in appliance housings in Porter Extended Channel. The matrix illustrates industry standard configurations and Extended Channel handle locations, based on stocked sizes from the Porter range. Whilst the majority of these configurations eradicates the need for fillers, there are a few instances where a filler is required (see in matrix).

Please note: Aperture sizes shown with the actual appliance size shown below in brackets.

TALL HEIGHT INSTALLATION

To be used with 600mm wide appliances

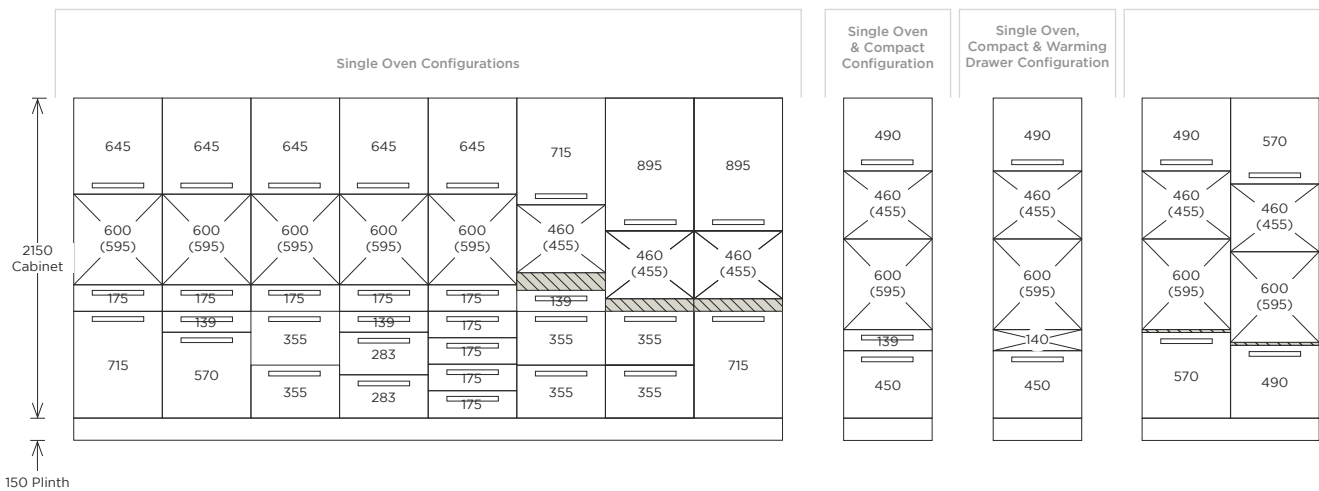

MEDIUM HEIGHT INSTALLATION

To be used with 600mm wide appliances

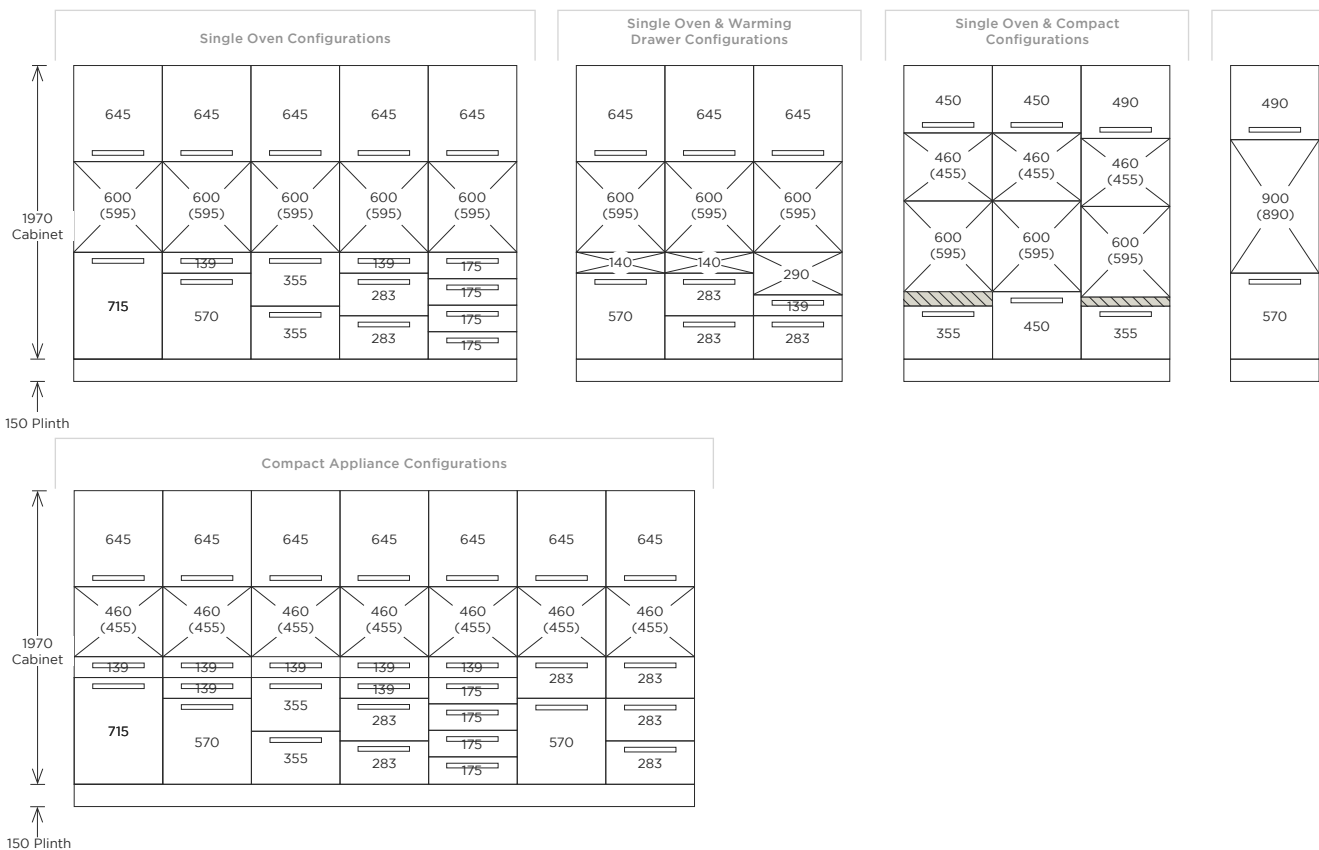

HANDLE LOCATION

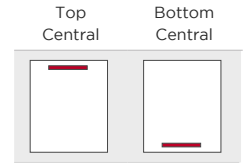

Recommended handle locations are illustrated on the doors below.



Single Oven & Microwave or Coffee Machine Configurations

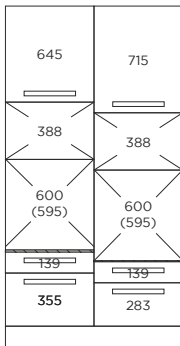

Double Oven Configurations

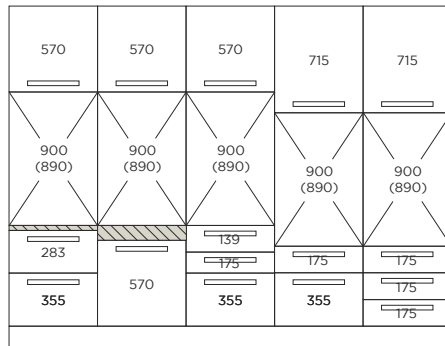

Fridge/Freezer Configurations

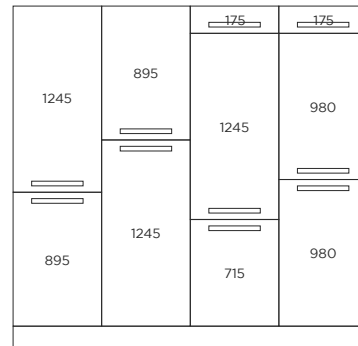

Double Oven Configurations

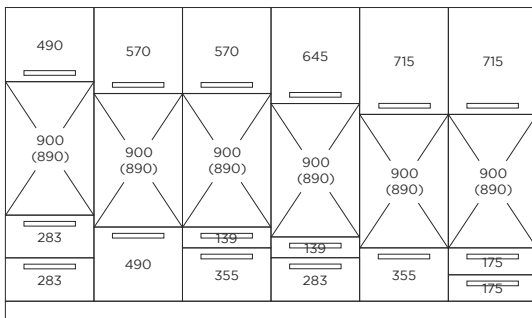

Compact & Warming Drawer Configurations

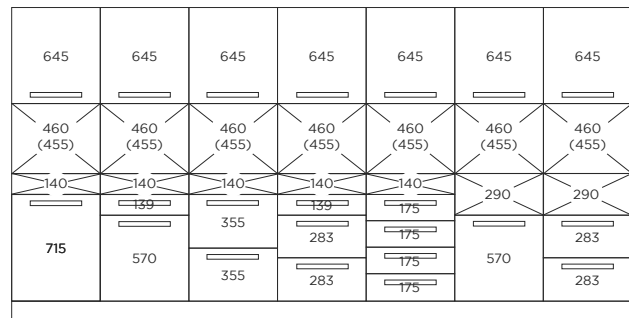

Fridge/Freezer Configurations

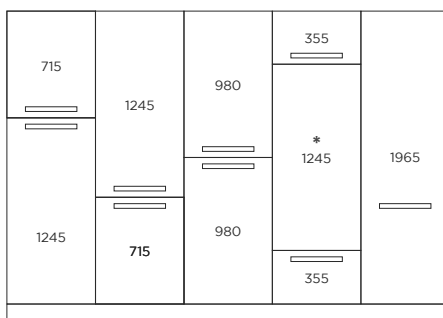

Please note:
* Mounted handle recommended on configuration

Please note:
- Specialist appliance brands such as Miele, Sub Zero and Wolf adopt a different size matrix.
- If fillers must be used, typically a 139 x 597mm drawer front or 115 x 597mm oven trimmer are the most recommended products. Cut to size along the length to suit the void, and finish the raw edge using a PWS touch up kit.

Please note
*Not all handle locations available (please see 'Handle Location Guide' for more information)

HUNTON



Available in
Kitchens



Available in
Bedrooms



Available in
Home Office

A unique, modern Shaker, Hunton features a narrow frame design, one-piece construction, and smooth painted finish creating a truly versatile Shaker that suits any room setting.

1 HANDLE OPTION AVAILABLE

Pick your
backplate finish -
8 options available

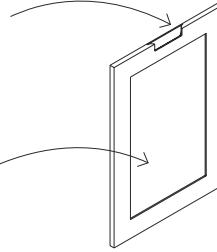

Pick your
frontal colour -
35 colours to
choose from

EDGE
Page 60



EDGE

Example shown - Hunton Edge,
Frontal: Corpse Green, Backplate: Brushed Brass



EDGE

Example shown - Hunton Edge,
Frontal: Ives Blue, Backplate: Brushed Brass



EDGE

Example shown - Hunton Edge,
Frontal: Pimento, Backplate: Oak



EDGE

Example shown - Hunton Edge,
Frontal: Olive, Backplate: Carbon

FRONTAL COLOURS

STOCKED COLOURS - PREFIX HSO

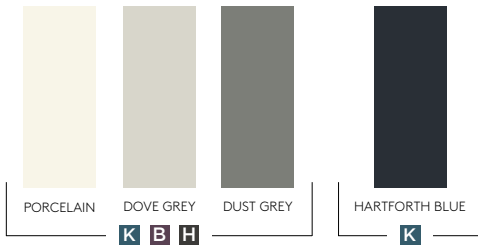

- K** Available in Kitchens
- B** Available in Bedrooms
- H** Available in Home Office

PAINT-TO-ORDER COLOURS - PREFIX HXO

NEUTRALS

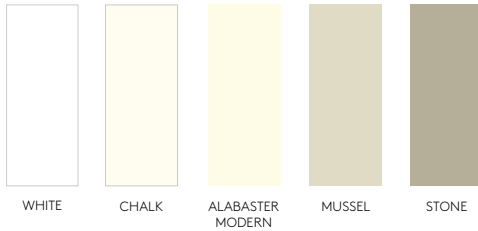

GREYS

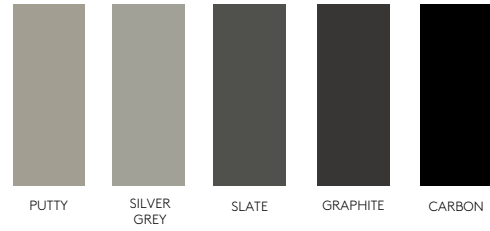

WARM NEUTRALS

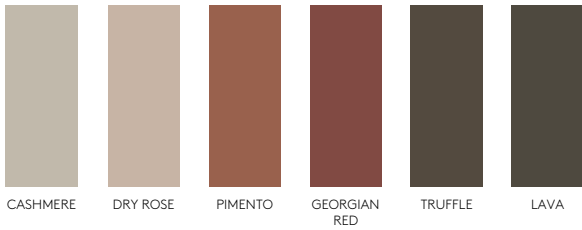

OLIVE GREENS

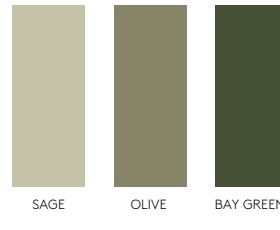

FOREST GREENS

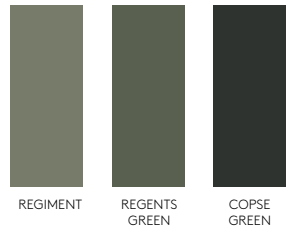

GREEN BLUES

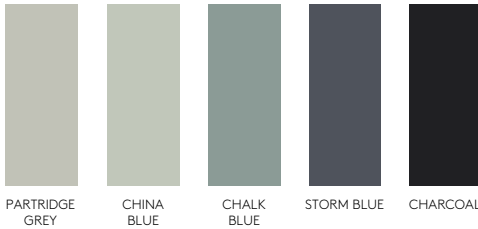

INK BLUES

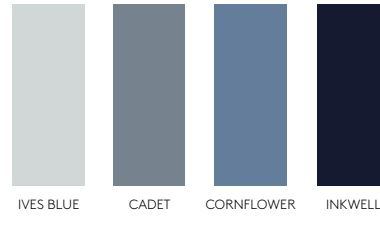

BACKPLATE FINISHES

TIMBER BACKPLATES (4mm)



METALLIC BACKPLATES (2mm)



PAINTED BACKPLATES (4mm)

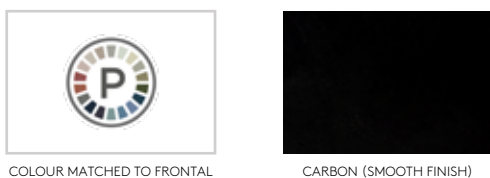

HUNTON EDGE

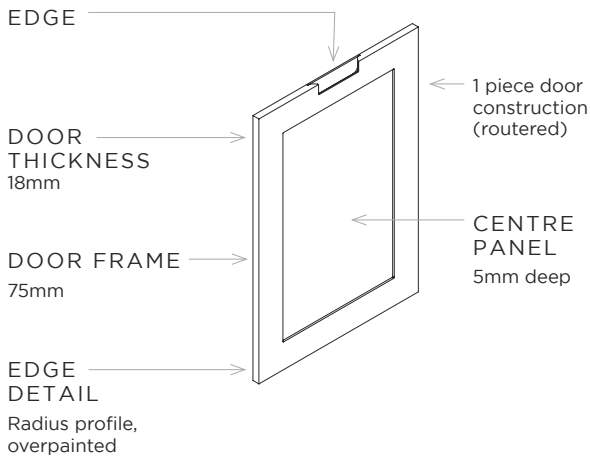

HUNTON SPECIFICATION

DOOR FAMILY STYLE	Narrow framed Shaker - 1 piece routed construction
DOOR THICKNESS	18mm
SUBSTRATE	HDF
FINISH	Matt painted (smooth finish)
REVERSE	Matching matt melamine reverse (PtO - matching matt painted reverse)
CERTIFICATION	Fira Gold

HANDLE LOCATION

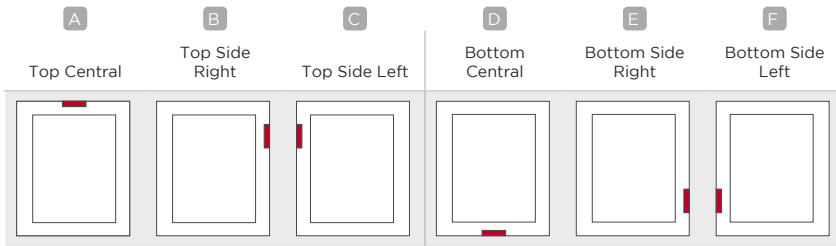

Note: This does not apply to 1965 Larder Doors. Please see page 64 for fixed handle height and lining through details.

HANDLE SPECIFICATION

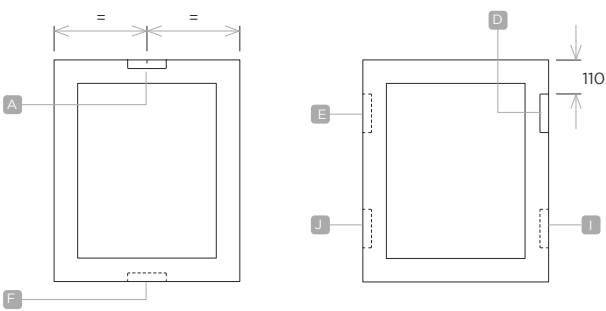

ROUTER SPECIFICATION

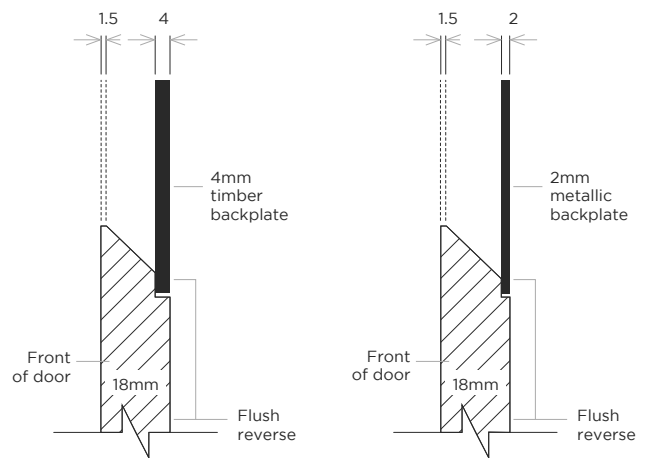

4mm TIMBER BACKPLATES

2mm METALLIC BACKPLATES

Note: For a flush reverse, doors are processed accordingly, to accommodate metallic and timber backplates.



Hunton Edge Porcelain shown with Matching and Carbon backplates

HUNTON EDGE

code	(HxW)	Top Central	Bottom Central
Drawer fronts			
***85x597	85x597mm	✓	-
***85x797	85x797mm	✓	-
***85x997	85x997mm	✓	-
****143	139x297mm	✓	✓
****144	139x397mm	✓	✓
***139X447	139x447mm	✓	✓
****145	139x497mm	✓	✓
****146	139x597mm	✓	✓
****148	139x797mm	✓	✓
****149	139x897mm	✓	✓
****140	139x997mm	✓	✓
***174	175x397mm	✓	✓
***175	175x497mm	✓	✓
***176	175x597mm	✓	✓

KEY INFORMATION

Frontal Prefix Codes
 Stocked - **HSO**
 Paint-to-order - **HXO**



*Subject to capacity

X The following frontal sizes from stocked Hunton are not available in Hunton Edge

- ***116 115x597mm (slab)
- ***CD716 715x300mm, Small Curved Door

		Top Central	Top Side Right	Top Side Left	Bottom Central	Bottom Side Right	Bottom Side Left
Drawer fronts							
***215x397	215x397mm	✓	-	-	✓	-	-
***215x497	215x497mm	✓	-	-	✓	-	-
***215x797	215x797mm	✓	-	-	✓	-	-
***215x997	215x997mm	✓	-	-	✓	-	-
***285	283x497mm	✓	-	-	✓	-	-
***286	283x597mm	✓	-	-	✓	-	-
***288	283x797mm	✓	-	-	✓	-	-
***289	283x897mm	✓	-	-	✓	-	-
***280	283x997mm	✓	-	-	✓	-	-
***326AF	325x597mm	✓	-	-	✓	-	-
***335X458	335X458mm, American fridge freezer door	✓	✓	✓	✓	✓	✓
***355	355x497mm	✓	✓	✓	✓	✓	✓
***356	355x597mm	✓	✓	✓	✓	✓	✓
***358	355x797mm	✓	-	-	✓	-	-
***359	355x897mm	✓	-	-	✓	-	-
***350	355x997mm	✓	-	-	✓	-	-
***355X1197	355x1197mm	✓	-	-	✓	-	-

		Top Central	Top Side Right	Top Side Left	Bottom Central	Bottom Side Right	Bottom Side Left
Doors							
***406	400x597mm	✓	✓	✓	✓	✓	✓
***447x397	447x397mm	✓	✓	✓	✓	✓	✓
***447x447	447x447mm	✓	✓	✓	✓	✓	✓
***447x597	447x597mm	✓	✓	✓	✓	✓	✓
***456	450x597mm	✓	✓	✓	✓	✓	✓
***494	490x397mm, double farmhouse door	✓	✓	✓	✓	✓	✓
***496	490x597mm, farmhouse door	✓	✓	✓	✓	✓	✓
***573	570x297mm	✓	✓	✓	✓	✓	✓
***574	570x397mm	✓	✓	✓	✓	✓	✓
***570X447	570x447mm	✓	✓	✓	✓	✓	✓
***575	570x497mm	✓	✓	✓	✓	✓	✓
***576	570x597mm	✓	✓	✓	✓	✓	✓
***646	645x597mm	✓	✓	✓	✓	✓	✓
***686AF	685x597mm	✓	✓	✓	✓	✓	✓
***715X147	715x147mm (slab)	-	✓	✓	-	✓	✓
***713	715x297mm	✓	✓	✓	✓	✓	✓
***715X347	715x347mm	✓	✓	✓	✓	✓	✓
***714	715x397mm	✓	✓	✓	✓	✓	✓
***715X447	715x447mm	✓	✓	✓	✓	✓	✓
***715	715x497mm	✓	✓	✓	✓	✓	✓
***715X547	715x547mm	✓	✓	✓	✓	✓	✓
***716	715x597mm	✓	✓	✓	✓	✓	✓
Doors							
***896NC	895x597mm, (no cross rail)	-	-	-	✓	✓	✓
***986	980x597mm	✓	✓	✓	✓	✓	✓
***826	825x597mm with cross rail	-	-	-	✓	✓	✓
***893	895x297mm with cross rail	-	-	-	✓	✓	✓
***894	895x397mm with cross rail	-	-	-	✓	✓	✓
***895X447	895x447mm with cross rail	-	-	-	✓	✓	✓
***895	895x497mm with cross rail	-	-	-	✓	✓	✓
***896	895x597mm with cross rail	-	-	-	✓	✓	✓

HUNTON EDGE

		Top Central	Top Side Right	Top Side Left	Bottom Central	Bottom Side Right	Bottom Side Left
Larder doors							
***123	1245x297mm	✓	✓	✓	✓	✓	✓
***124	1245x397mm	✓	✓	✓	✓	✓	✓
***125	1245x497mm	✓	✓	✓	✓	✓	✓
***126	1245x597mm	✓	✓	✓	✓	✓	✓
***1425X297	1425x297mm with cross rail	-	-	-	✓	✓	✓
***1425X597	1425x597mm with cross rail	-	-	-	✓	✓	✓

Note: • 1965 Larder Doors have a fixed handle height of 889mm. This lines through with adjacent 1245mm door configurations (70/30 F/F).
• Larder doors are handed









		Fixed Right	Fixed Left
Tall larder doors			
***193	1965x297mm, (3 panel design, with 2 cross rails)	✓	✓
***196	1965x597mm, (3 panel design, with 2 cross rails)	✓	✓

Note: • Robe doors are handed

		Fixed Right	Fixed Left
Robe doors			
***2154x397	2154x397mm, (4 panel design, with 3 cross rails)	✓	✓
***2154x447	2154x447mm, (4 panel design, with 3 cross rails)	✓	✓
***2154x497	2154x497mm, (4 panel design, with 3 cross rails)	✓	✓

		Top Central	Top Side Right	Top Side Left	Bottom Central	Bottom Side Right	Bottom Side Left
Corner Doors							
***WCDS	715x277x18mm Wall corner door solution, (pair)	-	-	-	✓	✓	✓
***CDS	715x315x18mm corner door solution, (pair)	✓	✓	✓	-	-	-

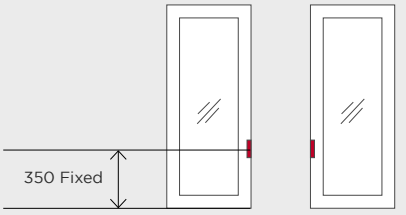
Note: Corner doors come as a pair. Handle features on one door only.

		Top Central	Top Side Right	Top Side Left	Bottom Central	Bottom Side Right	Bottom Side Left
Glazed doors - clear glazed							
***714CG	715x397mm, clear glazed	✓	✓	✓	✓	✓	✓
***715CG	715x497mm, clear glazed	✓	✓	✓	✓	✓	✓
							
***1215X497CG	1215x497mm, clear glazed dresser					✓	✓
							
***895CG	895x497mm, clear glazed with cross rail				✓	✓	✓

KEY INFORMATION

Frontal Prefix Codes
Stocked - **HSO**
Paint-to-order - **HXO**

X The following frontal sizes from stocked Hunton are not available in Hunton Edge

***116 115x597mm (slab)

***CD716 715x300mm, Small Curved Door



*Subject to capacity

HUNTON EDGE

KITCHEN FASCIA MATRIX FOR LAY-ON DOORS

This matrix can be referred to when planning a design in Hunton Edge. The matrix illustrates recommended configurations and Edge handle locations, based on stocked sizes from the Hunton range. Please reference page 62-65 for 'Handle Location Guide'.

TALL HEIGHT INSTALLATION

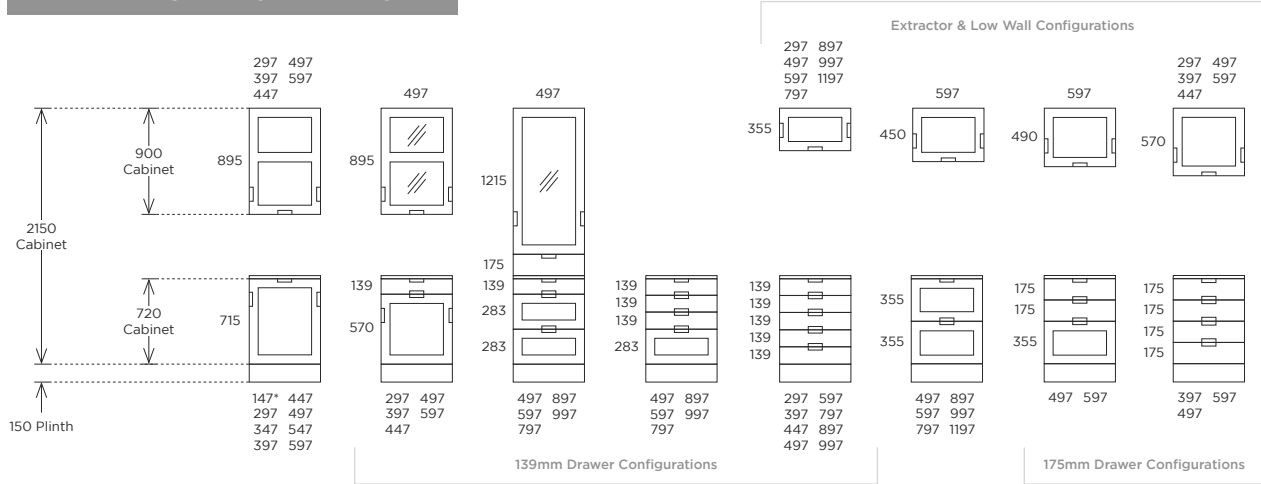

MEDIUM HEIGHT INSTALLATION

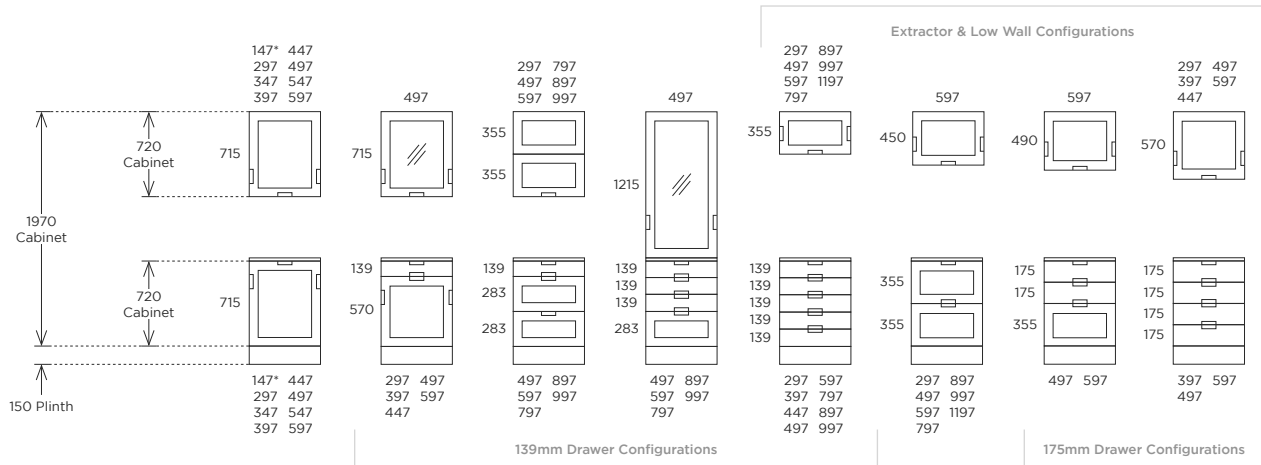

LOW HEIGHT INSTALLATION

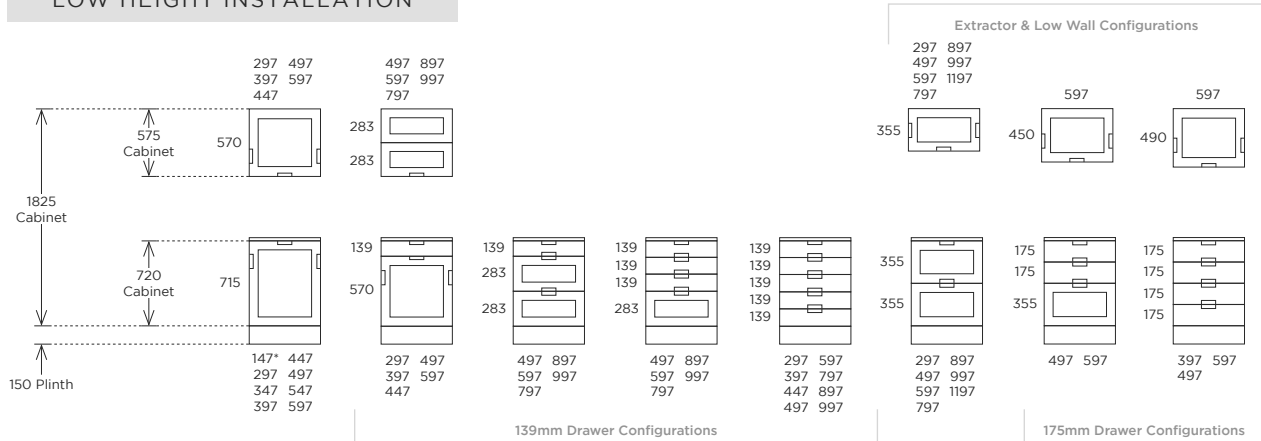

HANDLE LOCATION

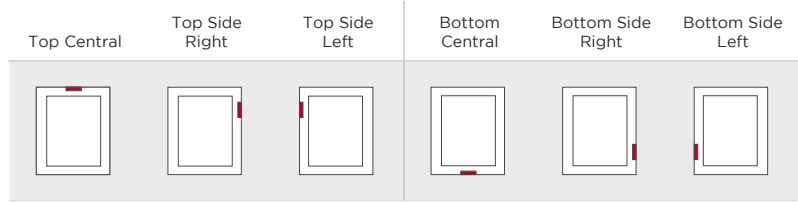

Recommended handle locations are illustrated on the doors below.

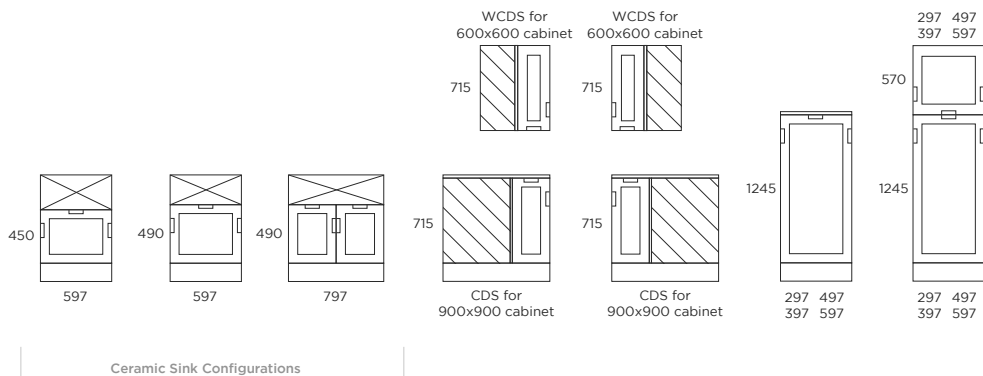
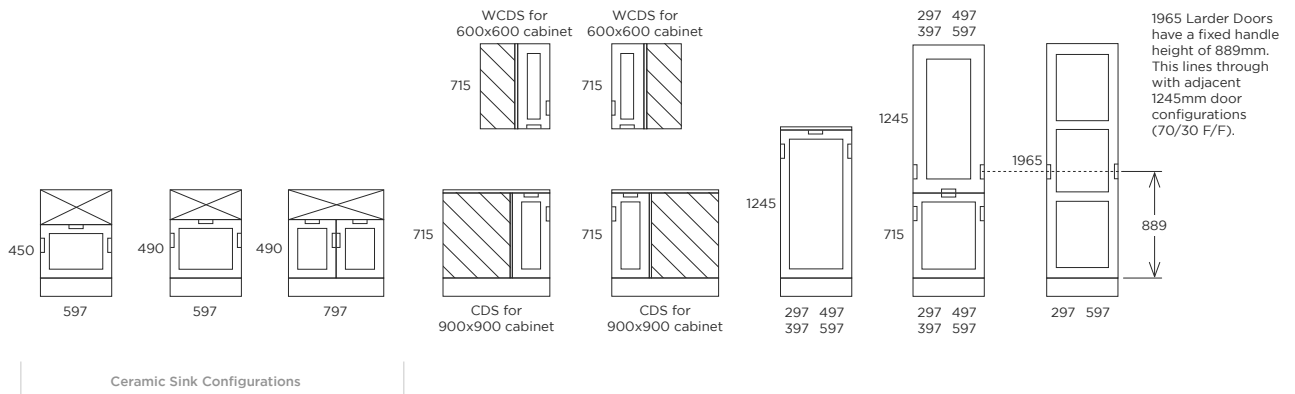
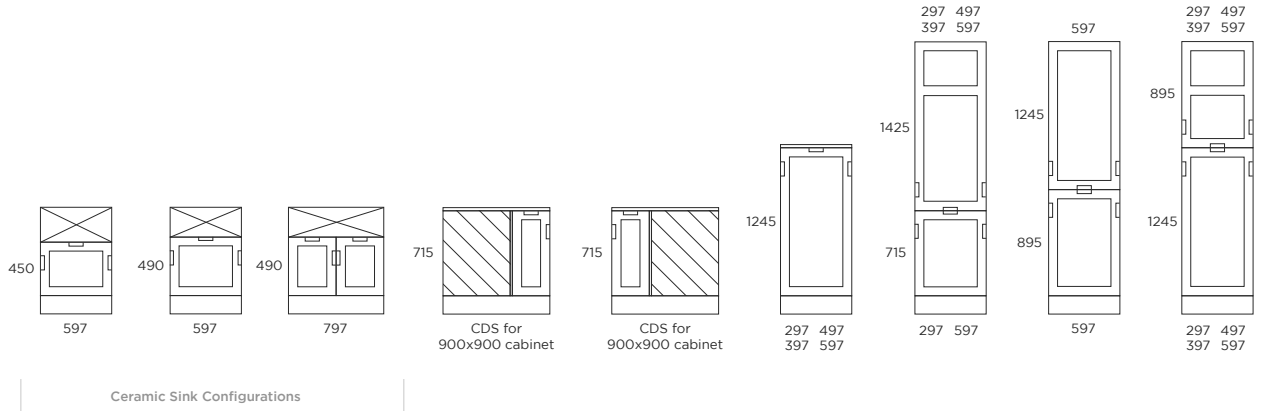

Please note
*Not all handle locations available (please see 'Handle Location Guide' for more information)

HUNTON EDGE

KITCHEN APPLIANCE MATRIX FOR LAY-ON DOORS

This matrix can be referred to when planning built-in appliance housings in Hunton Edge. The matrix illustrates industry standard configurations and Edge handle locations, based on stocked sizes from the Hunton range. Whilst the majority of these configurations eradicates the need for fillers, there are a few instances where a filler is required (see in matrix).

Please note: Aperture sizes shown with the actual appliance size shown below in brackets.

TALL HEIGHT INSTALLATION

To be used with 600mm wide appliances

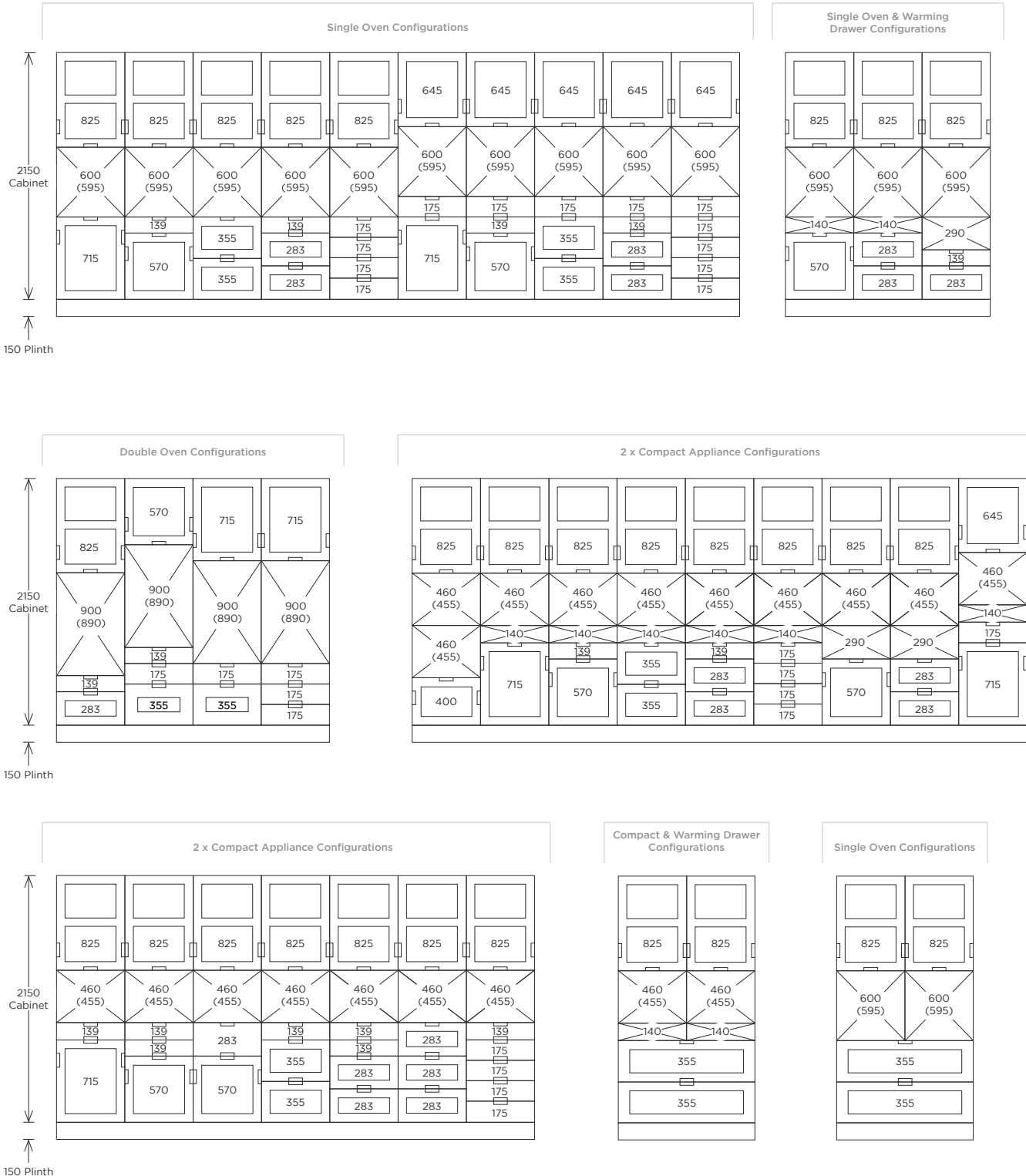

HANDLE LOCATION

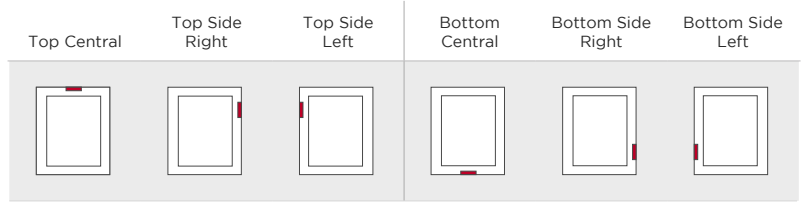

Recommended handle locations are illustrated on the doors below.

Single Oven & Compact Configurations

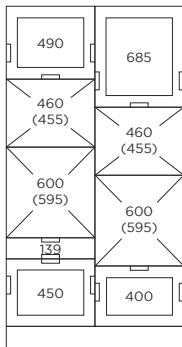

Single Oven, Compact & Warming Drawer Configuration

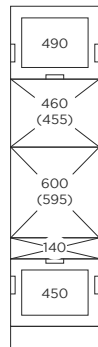

Single Oven & Microwave or Coffee Machine Configurations

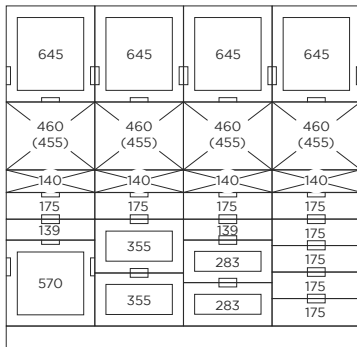
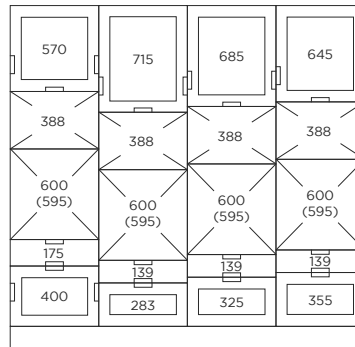

2 x Single Oven Configurations

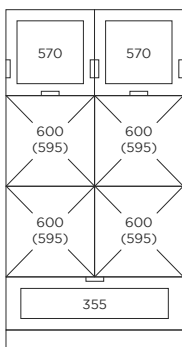

Single, Compact & Warming Drawer Configurations

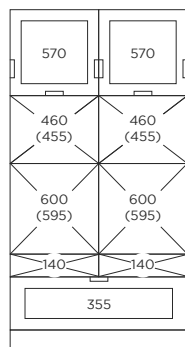

Please note
*Not all handle locations available (please see 'Handle Location Guide' for more information)

HUNTON EDGE

KITCHEN APPLIANCE MATRIX FOR LAY-ON DOORS

This matrix can be referred to when planning built-in appliance housings in Hunton Edge. The matrix illustrates industry standard configurations and Edge handle locations, based on stocked sizes from the Hunton range. Whilst the majority of these configurations eradicates the need for fillers, there are a few instances where a filler is required (see in matrix).

Please note: Aperture sizes shown with the actual appliance size shown below in brackets.

MEDIUM HEIGHT INSTALLATION To be used with 600mm wide appliances

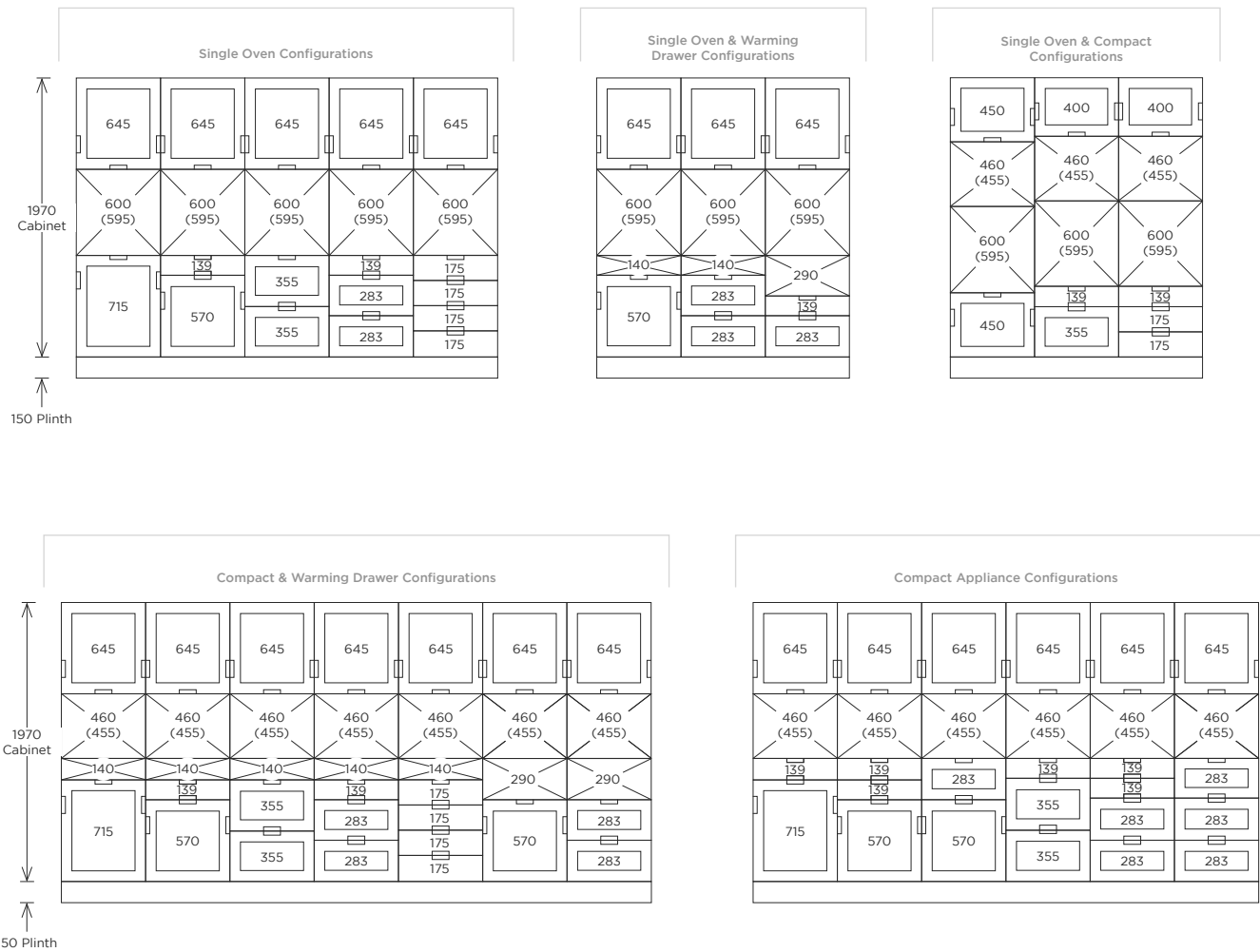

HANDLE LOCATION

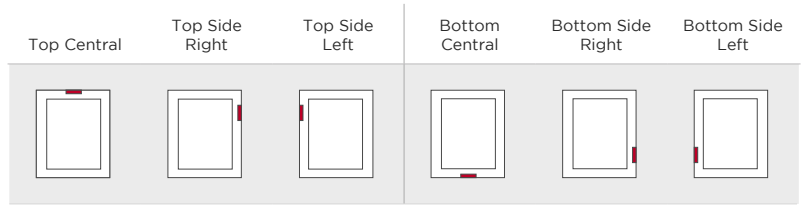

Recommended handle locations are illustrated on the doors below.

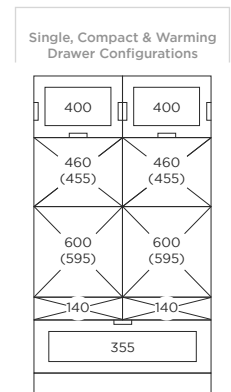
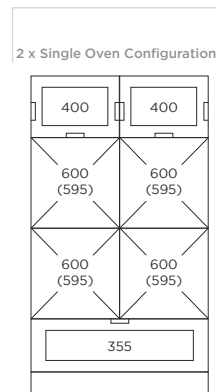
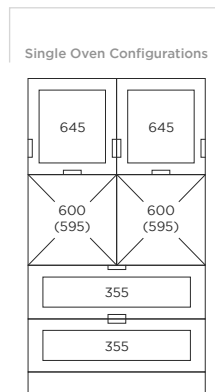
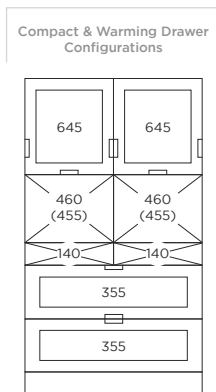
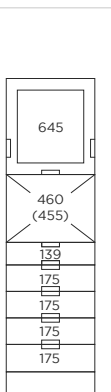
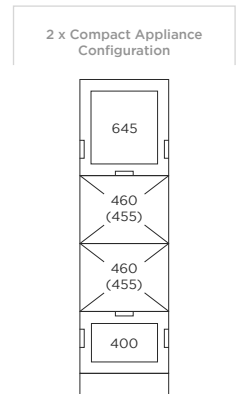
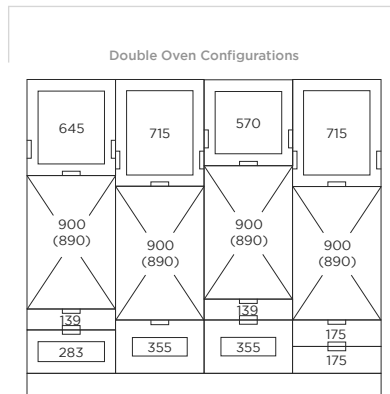
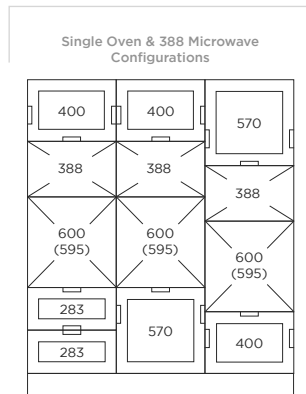
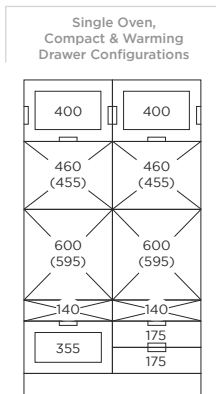

Please note
*Not all handle locations available (please see 'Handle Location Guide' for more information)

FITZROY

Our popular, single piece Shaker works equally well in both modern and classic settings. Fitzroy's classic proportions and smooth painted finish combine to create a classic door range with a modern touch.

2 HANDLE OPTIONS AVAILABLE

Pick your
backplate finish -
8 options available

Pick your
frontal colour -
35 colours to
choose from

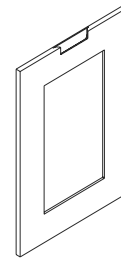
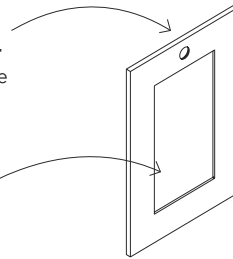

PORTAL
Page 74

EDGE
Page 84



○
PORTAL

Example shown - Fitzroy Portal,
Frontal: Ives Blue, Backplate: Matching



○
PORTAL

Example shown - Fitzroy Portal,
Frontal: Silver Grey, Backplate: Carbon



▭
EDGE

Example shown - Fitzroy Edge,
Frontal: Hartforth Blue, Backplate: Oak



▭
EDGE

Example shown - Fitzroy Edge,
Frontal: Carbon, Backplate: Bright Copper

FRONTAL COLOURS

STOCKED COLOURS - PREFIX FSO

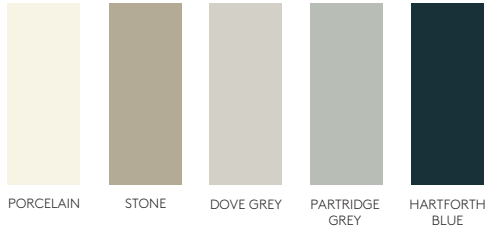

PAINT-TO-ORDER COLOURS - PREFIX FXO

NEUTRALS

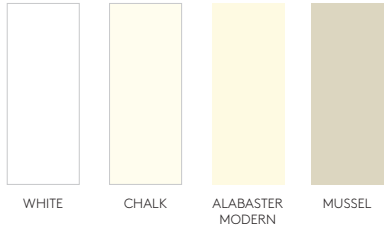

GREYS

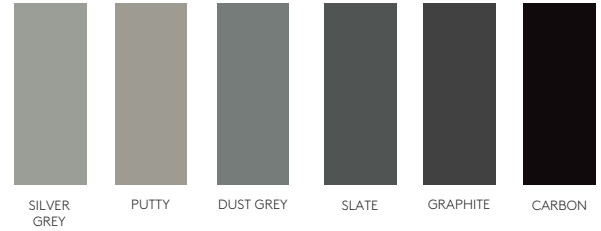

WARM NEUTRALS

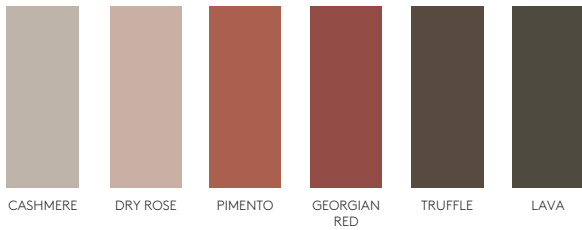

OLIVE GREENS

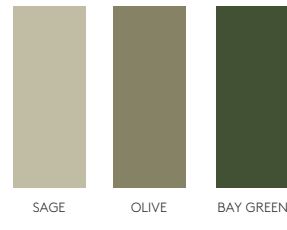

FOREST GREENS

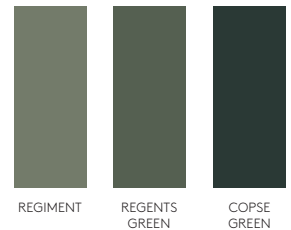

GREEN BLUES

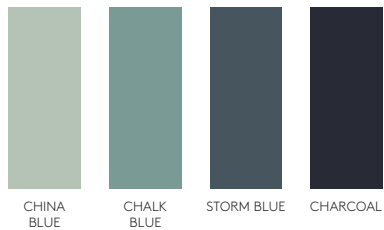

INK BLUES

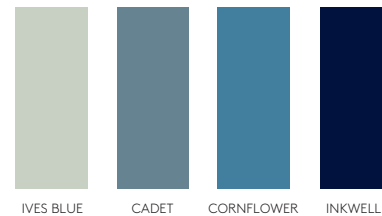

BACKPLATE FINISHES

TIMBER BACKPLATES

(4mm)



OAK

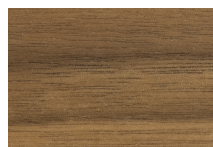

WALNUT

METALLIC BACKPLATES

(2mm)

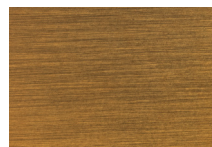

ANTIQUE BRONZE EFFECT



AGED BRASS

PAINTED BACKPLATES

(4mm)

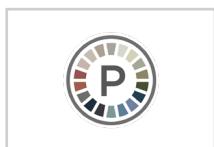

COLOUR MATCHED TO FRONTAL

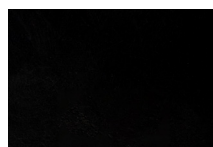

CARBON (SMOOTH FINISH)

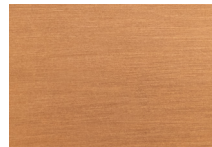

BRIGHT COPPER



BRUSHED BRASS

FITZROY PORTAL



Door Drilling Service



Painted Finish



6 Year Guarantee

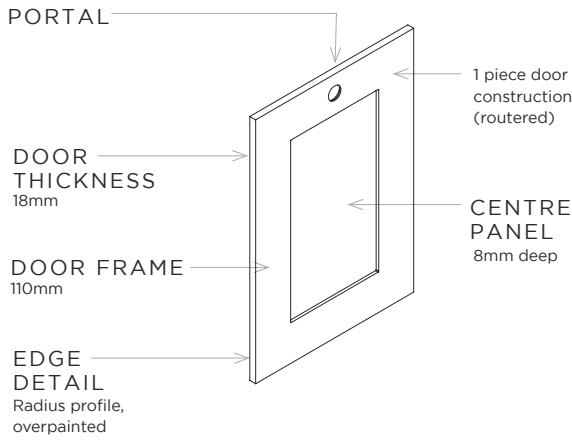

FITZROY SPECIFICATION

DOOR FAMILY STYLE	Shaker - 1 piece routed construction
DOOR THICKNESS	18mm
SUBSTRATE	HDF
FINISH	Matt painted (smooth finish)
REVERSE	Matching matt melamine reverse (PtO - painted as per front face)
CERTIFICATION	Fira Gold

HANDLE LOCATION

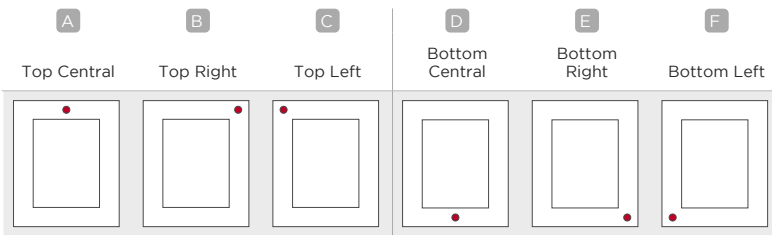

Note: This does not apply to 1965 Larder Doors.
Please see page 77 for fixed handle height and lining through details.

HANDLE SPECIFICATION

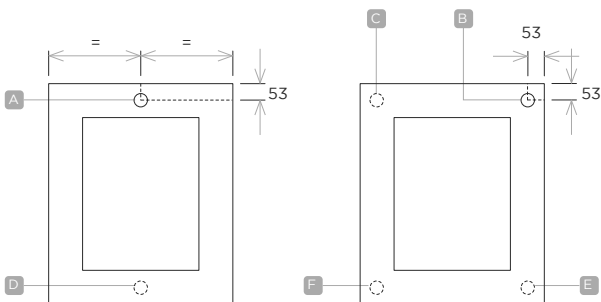

ROUTER SPECIFICATION

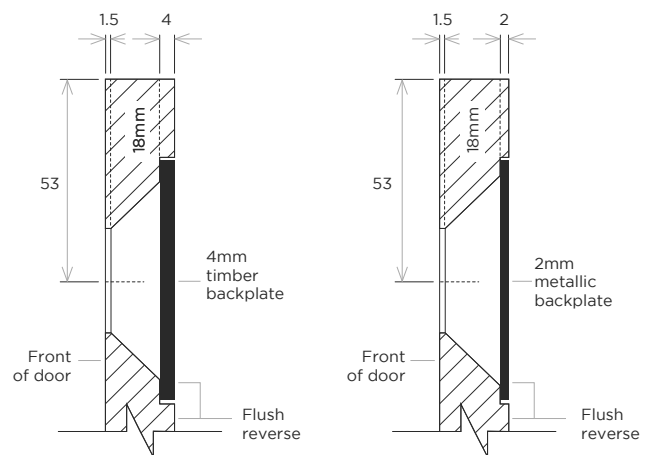

4mm TIMBER BACKPLATES

2mm METALLIC BACKPLATES

Note: For a flush reverse, doors are processed accordingly, to accommodate metallic and timber backplates.



Fitzroy Portal Cashmere shown with Walnut backplates

FITZROY PORTAL

code	(HxW)	Top Central
Drawer fronts		
***143	139x297mm	✓
***144	139x397mm	✓
***139X447	139x447mm	✓
***145	139x497mm	✓
***146	139x597mm	✓
***148	139x797mm	✓
***149	139x897mm	✓
***140	139x997mm	✓
***174	175x397mm	✓
***175	175x497mm	✓
***176	175x597mm	✓

KEY INFORMATION













Frontal Prefix Codes
 Stocked - **F50**
 Paint-to-order - **FX0**

X The following frontal sizes from stocked Fitzroy are not available in Fitzroy Portal

- ***116 115x597mm (slab)
- ***715X257 715x257mm
- ***CD716 715x300mm, Small Curved Door



*Subject to capacity

		Top Central	Top Right	Top Left	Bottom Central	Bottom Right	Bottom Left
Drawer fronts							
***285	283x497mm	✓	-	-	✓	-	-
***286	283x597mm	✓	-	-	✓	-	-
***288	283x797mm	✓	-	-	✓	-	-
***289	283x897mm	✓	-	-	✓	-	-
***280	283x997mm	✓	-	-	✓	-	-
***353	355x297mm	✓	✓	✓	✓	✓	✓
***355	355x497mm	✓	✓	✓	✓	✓	✓
***356	355x597mm	✓	✓	✓	✓	✓	✓
***358	355x797mm	✓	-	-	✓	-	-
***359	355x897mm	✓	-	-	✓	-	-
***350	355x997mm	✓	-	-	✓	-	-
Doors							
***456	450x597mm	✓	✓	✓	✓	✓	✓
***494	490x397mm	✓	✓	✓	✓	✓	✓
***496	490x597mm	✓	✓	✓	✓	✓	✓
***573	570x297mm	✓	✓	✓	✓	✓	✓
***574	570x397mm	✓	✓	✓	✓	✓	✓
***570X447	570x447mm	✓	✓	✓	✓	✓	✓
***575	570x497mm	✓	✓	✓	✓	✓	✓
***576	570x597mm	✓	✓	✓	✓	✓	✓
***646	645x597mm	✓	✓	✓	✓	✓	✓

		Top Central	Top Right	Top Left	Bottom Central	Bottom Right	Bottom Left
Doors							
***715X147	715x147mm (slab)	✓	-	-	✓	-	-
***713	715x297	✓	✓	✓	✓	✓	✓
***715X325	715x325mm	✓	✓	✓	✓	✓	✓
***715X347	715x347mm	✓	✓	✓	✓	✓	✓
***714	715x397mm	✓	✓	✓	✓	✓	✓
***715X447	715x447mm	✓	✓	✓	✓	✓	✓
***715	715x497mm	✓	✓	✓	✓	✓	✓
***715X547	715x547mm	✓	✓	✓	✓	✓	✓
***716	715x597mm	✓	✓	✓	✓	✓	✓
***893	895x297mm	✓	✓	✓	✓	✓	✓
***894	895x397mm	✓	✓	✓	✓	✓	✓
***895X447	895x447mm	✓	✓	✓	✓	✓	✓
***895	895x497mm	✓	✓	✓	✓	✓	✓
***896	895x597mm	✓	✓	✓	✓	✓	✓
***986	980x597mm	✓	✓	✓	✓	✓	✓
Larder doors							
***123	1245x297mm	✓	✓	✓	✓	✓	✓
***124	1245x397mm	✓	✓	✓	✓	✓	✓
***125	1245x497mm	✓	✓	✓	✓	✓	✓
***126	1245x597mm	✓	✓	✓	✓	✓	✓

		Fixed Central	Fixed Right	Fixed Left
<p>Note: • 1965mm Larder doors have a fixed handle position to line through with adjacent 715 base door configurations.</p> <p>• Larder doors are handed</p>				
<p>662 Fixed</p>				
Tall larder doors				
***193	1965x297mm (cross rail)	✓	✓	✓
***196	1965x597mm (cross rail)	✓	✓	✓

FITZROY PORTAL

See
Fascia &
appliance
matrix
page 80-83

		Top Central	Top Right	Top Left	Bottom Central	Bottom Right	Bottom Left
Corner doors							
***WCDS	715x277x18mm wall corner door, solution, (pair)	-	-	-	✓	✓	✓
***CDS	715x315x18mm corner door solution, (pair)	✓	✓	✓	-	-	-

Note: Corner doors come as a pair. Handle features on one door only.

		Top Central	Top Right	Top Left	Bottom Central	Bottom Right	Bottom Left
Glazed doors							
***324FG	320x397mm, clear glazed	✓	✓	✓	✓	✓	✓
***325FG	320x497mm, clear glazed	✓	✓	✓	✓	✓	✓
***714FG	715x397mm, clear glazed	✓	✓	✓	✓	✓	✓
***715FG	715x497mm, clear glazed	✓	✓	✓	✓	✓	✓
***895FG	895x497mm, clear glazed	✓	✓	✓	✓	✓	✓

KEY INFORMATION

Frontal Prefix Codes
Stocked - **FSO**
Paint-to-order - **FXO**

X The following frontal sizes from stocked Fitzroy are not available in Fitzroy Portal

***116 115x597mm (slab)

***715X257 715x257mm

***CD716 715x300mm, Small Curved Door



*Subject to capacity



Fitzroy Portal Ives Blue shown with Matching backplates

HANDLE LOCATION

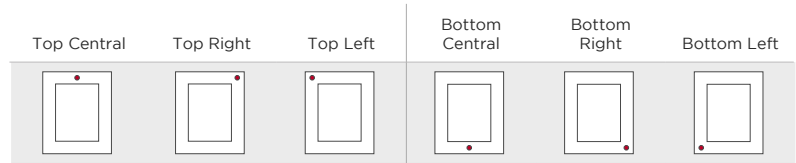

Recommended handle locations are illustrated on the doors below.

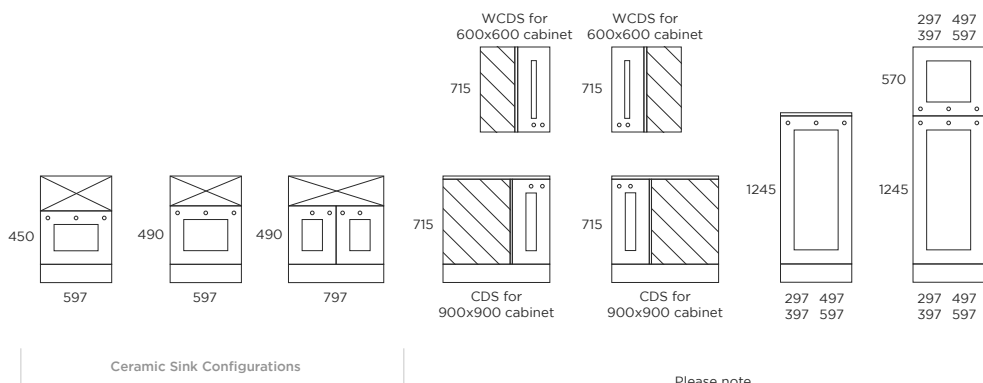
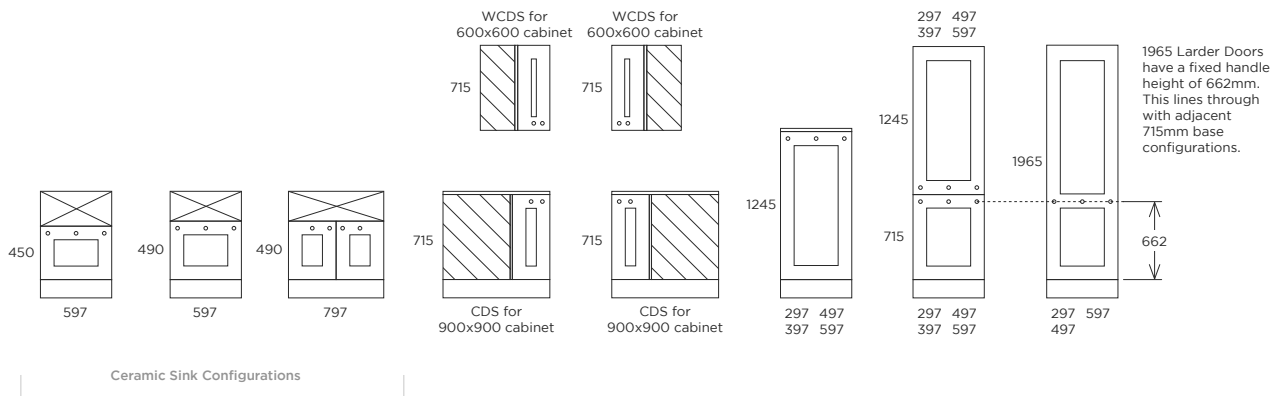
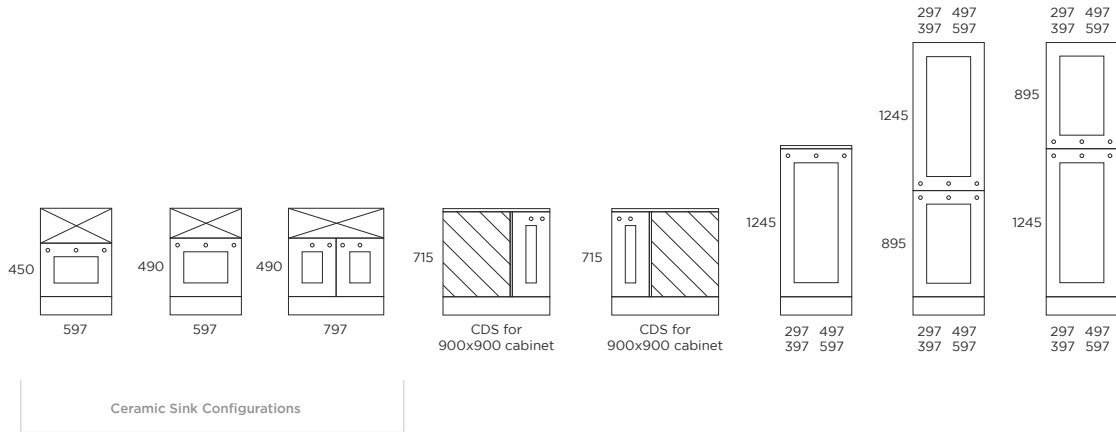

Please note
*Not all handle locations available (please see 'Handle Location Guide' for more information)

FITZROY PORTAL

KITCHEN APPLIANCE MATRIX FOR LAY-ON DOORS

This matrix can be referred to when planning built-in appliance housings in Fitzroy Portal. The matrix illustrates industry standard configurations and Portal handle locations, based on stocked sizes from the Fitzroy range. Whilst the majority of these configurations eradicates the need for fillers, there are a few instances where a filler is required (see in matrix).

Please note: Aperture sizes shown with the actual appliance size shown below in brackets.

TALL HEIGHT INSTALLATION

To be used with 600mm wide appliances

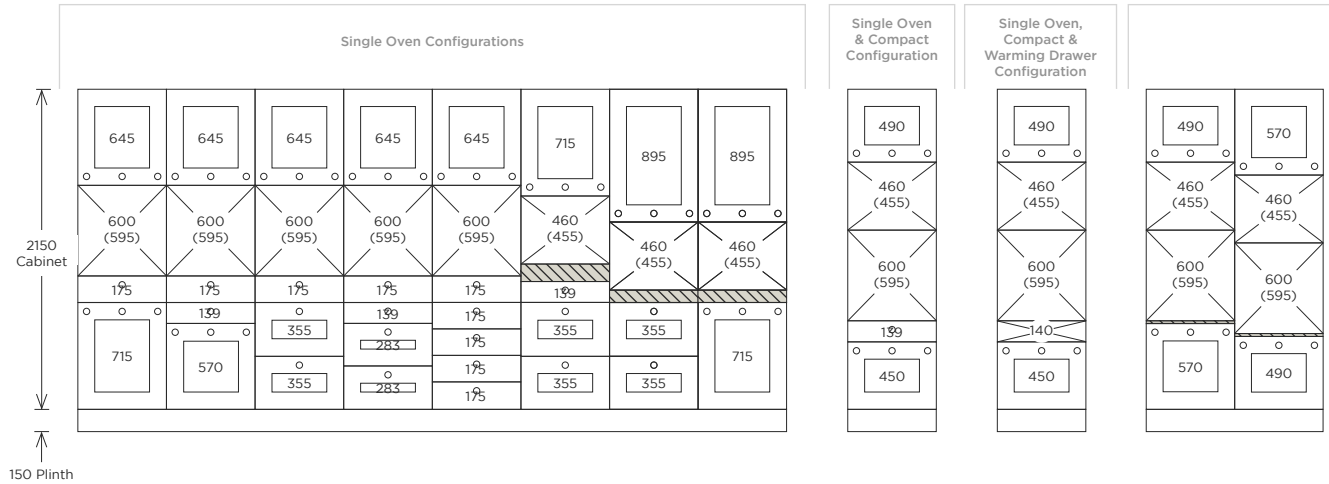

MEDIUM HEIGHT INSTALLATION

To be used with 600mm wide appliances

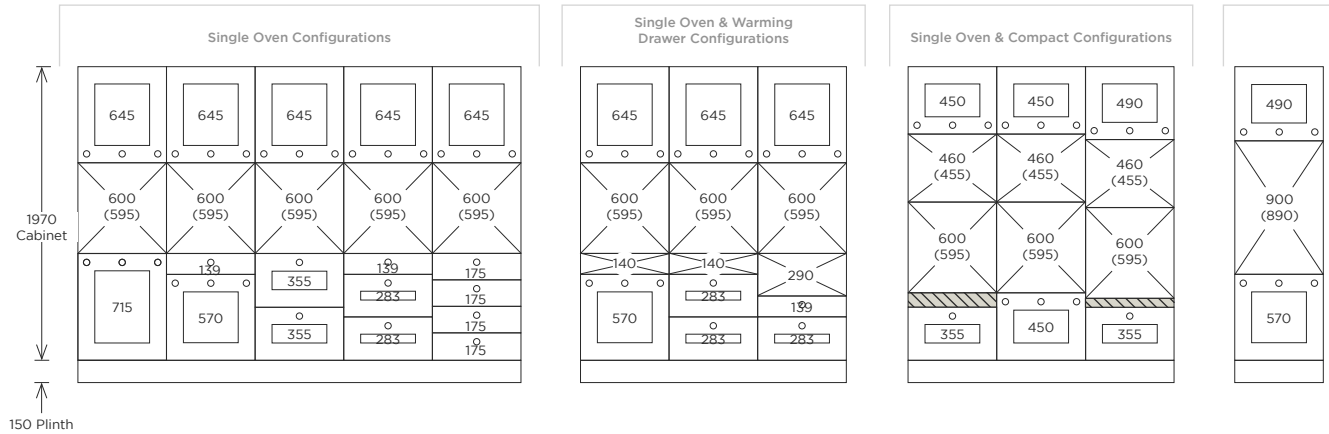

HANDLE LOCATION

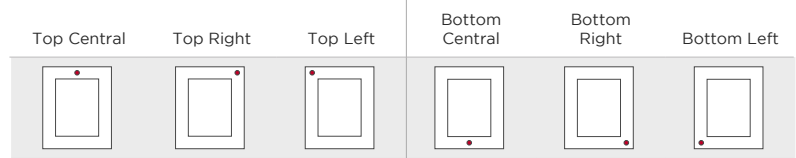

Recommended handle locations are illustrated on the doors below.

 Filler Required

Single Oven & Microwave or Coffee Machine Configurations

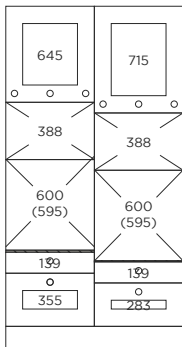

Double Oven Configurations

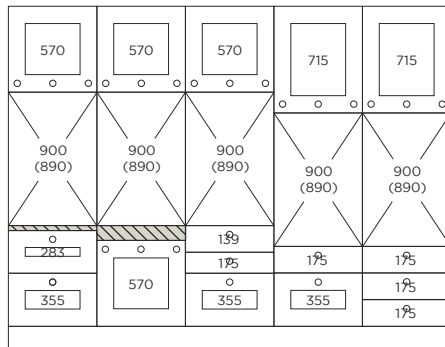

Fridge/Freezer Configurations

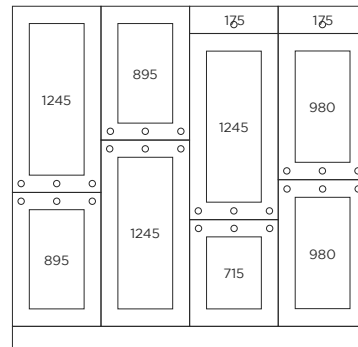

Please note: For Fridge/Freezer Doors it is recommended to use Right or Left handle locations.

Double Oven Configurations

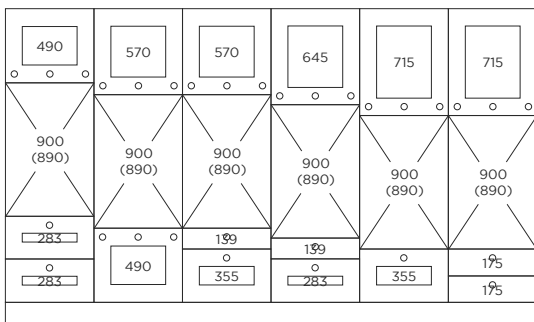

Compact & Warming Drawer Configurations

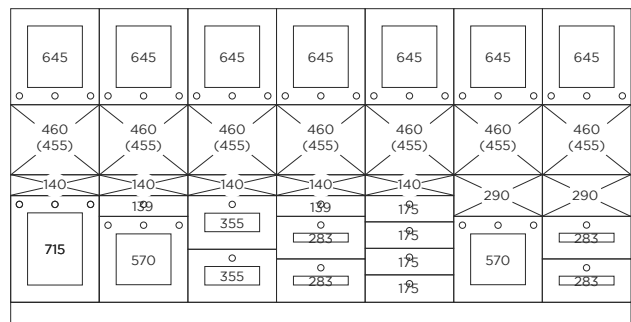

Fridge/Freezer Configurations

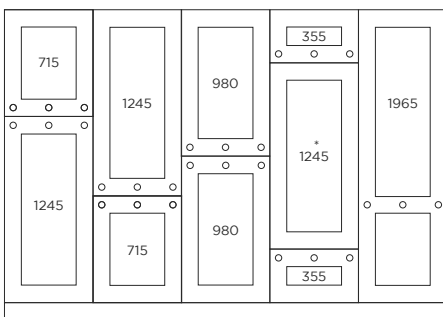

Please note: For Fridge/Freezer Doors it is recommended to use Right or Left handle locations.

Please note:

* Mounted handle recommended on configuration

Please note:

- Specialist appliance brands such as Miele, Sub Zero and Wolf adopt a different size matrix.
- If fillers must be used, typically a 139 x 597mm drawer front or 115 x 597mm oven trimmer are the most recommended products. Cut to size along the length to suit the void, and finish the raw edge using a PWS touch up kit.

Please note

*Not all handle locations available (please see 'Handle Location Guide' for more information)

FITZROY EDGE

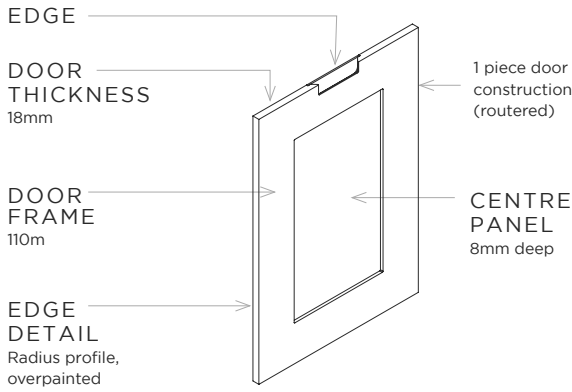

FITZROY SPECIFICATION

DOOR FAMILY STYLE	Shaker - 1 piece routed construction
DOOR THICKNESS	18mm
SUBSTRATE	HDF
FINISH	Matt painted (smooth finish)
REVERSE	Matching matt melamine reverse (PtO - painted as per front face)
CERTIFICATION	Fira Gold

HANDLE LOCATION

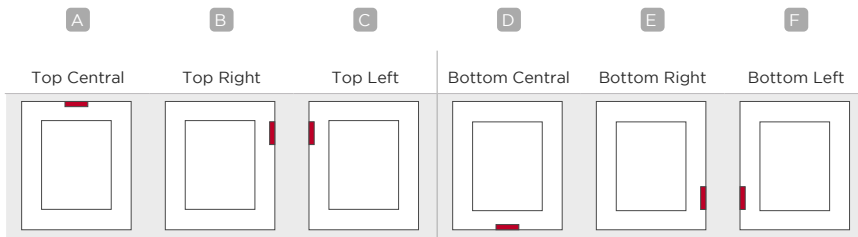

Note: This does not apply to 1965 Larder Doors.
Please see page 87 for fixed handle height and lining through details.

HANDLE SPECIFICATION

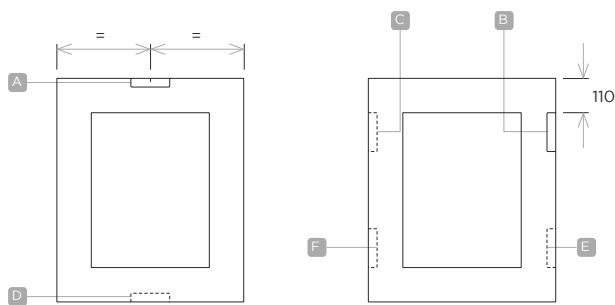

ROUTER SPECIFICATION

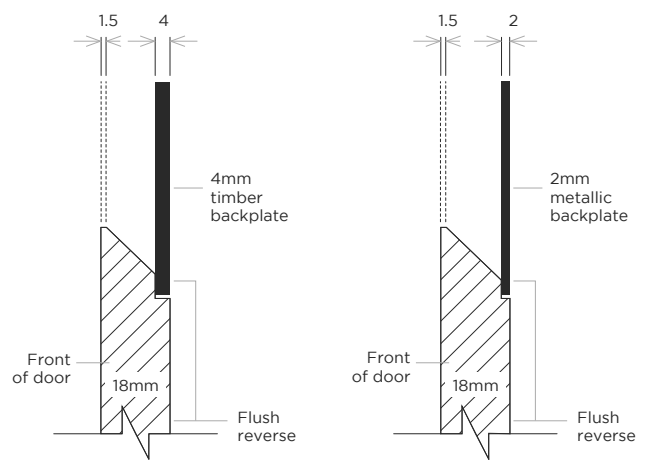

4mm TIMBER BACKPLATES



2mm METALLIC BACKPLATES

Note: For a flush reverse, doors are processed accordingly, to accommodate metallic and timber backplates.



Fitzroy Edge Slate shown with Antique Bronze backplate

FITZROY EDGE

code	(HxW)	Top Central	Bottom Central
Drawer fronts			
***143	139x297mm		
***144	139x397mm	✓	✓
***139X447	139x447mm	✓	✓
***145	139x497mm	✓	✓
***146	139x597mm	✓	✓
***148	139x797mm	✓	✓
***149	139x897mm	✓	✓
***140	139x997mm	✓	✓
***174	175x397mm	✓	✓
***175	175x497mm	✓	✓
***176	175x597mm	✓	✓

KEY INFORMATION













Frontal Prefix Codes
 Stocked - **FSO**
 Paint-to-order - **FXO**

X The following frontal sizes from stocked Fitzroy are not available in Fitzroy Edge

- ***116 115x597mm (slab)
- ***715X257 715x257mm
- ***CD716 715x300mm, Small Curved Door



*Subject to capacity

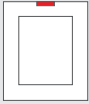
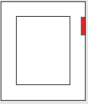
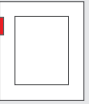
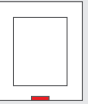
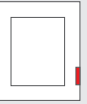
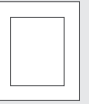

		Top Central	Top Side Right	Top Side Left	Bottom Central	Bottom Side Right	Bottom Side Left
Drawer fronts							
							
***285	283x497mm	✓	-	-	✓	-	-
***286	283x597mm	✓	-	-	✓	-	-
***288	283x797mm	✓	-	-	✓	-	-
***289	283x897mm	✓	-	-	✓	-	-
***280	283x997mm	✓	-	-	✓	-	-
***353	355x297mm	✓	✓	✓	✓	✓	✓
***355	355x497mm	✓	✓	✓	✓	✓	✓
***356	355x597mm	✓	✓	✓	✓	✓	✓
***358	355x797mm	✓	-	-	✓	-	-
***359	355x897mm	✓	-	-	✓	-	-
***350	355x997mm	✓	-	-	✓	-	-
Doors							
							
***456	450x597mm	✓	✓	✓	✓	✓	✓
***494	490x397mm	✓	✓	✓	✓	✓	✓
***496	490x597mm	✓	✓	✓	✓	✓	✓
***573	570x297mm	✓	✓	✓	✓	✓	✓
***574	570x397mm	✓	✓	✓	✓	✓	✓
***570X447	570x447mm	✓	✓	✓	✓	✓	✓
***575	570x497mm	✓	✓	✓	✓	✓	✓
***576	570x597mm	✓	✓	✓	✓	✓	✓
***646	645x597mm	✓	✓	✓	✓	✓	✓

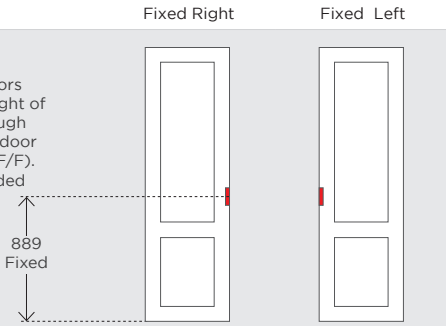
		Top Central	Top Side Right	Top Side Left	Bottom Central	Bottom Side Right	Bottom Side Left
Doors							
***715X147	715x147mm (slab)	-	✓	✓	-	✓	✓
***713	715x297	✓	✓	✓	✓	✓	✓
***715X325	715x325mm	✓	✓	✓	✓	✓	✓
***715X347	715x347mm	✓	✓	✓	✓	✓	✓
***714	715x397mm	✓	✓	✓	✓	✓	✓
***715X447	715x447mm	✓	✓	✓	✓	✓	✓
***715	715x497mm	✓	✓	✓	✓	✓	✓
***715X547	715x547mm	✓	✓	✓	✓	✓	✓
***716	715x597mm	✓	✓	✓	✓	✓	✓
***893	895x297mm	✓	✓	✓	✓	✓	✓
***894	895x397mm	✓	✓	✓	✓	✓	✓
***895X447	895x447mm	✓	✓	✓	✓	✓	✓
***895	895x497mm	✓	✓	✓	✓	✓	✓
***896	895x597mm	✓	✓	✓	✓	✓	✓
***986	980x597mm	✓	✓	✓	✓	✓	✓
Larder doors							
***123	1245x297mm	✓	✓	✓	✓	✓	✓
***124	1245x397mm	✓	✓	✓	✓	✓	✓
***125	1245x497mm	✓	✓	✓	✓	✓	✓
***126	1245x597mm	✓	✓	✓	✓	✓	✓



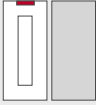
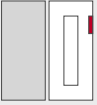
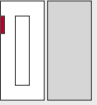
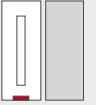
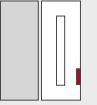

		Fixed Right	Fixed Left
<p>Note: • 1965 Larder Doors have a fixed handle height of 889mm. This lines through with adjacent 1245mm door configurations (70/30 F/F).</p> <p>• Larder doors are handed</p> 			
***193	1965x297mm (cross rail)	✓	✓
***196	1965x597mm (cross rail)	✓	✓

FITZROY EDGE

See
Fascia &
appliance
matrix
page 90-93

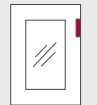
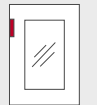
		Top Central	Top Side Right	Top Side Left	Bottom Central	Bottom Side Right	Bottom Side Left
Corner doors							
***WCDS	715x277x18mm wall corner door, solution, (pair)	-	-	-	✓	✓	✓
***CDS	715x315x18mm corner door solution, (pair)	✓	✓	✓	-	-	-

Note: Corner doors come as a pair. Handle features on one door only.

		Top Central	Top Side Right	Top Side Left	Bottom Central	Bottom Side Right	Bottom Side Left
Glazed doors							
***324FG	320x397mm, clear glazed	✓	-	-	✓	-	-
***325FG	320x497mm, clear glazed	✓	-	-	✓	-	-
***714FG	715x397mm, clear glazed	✓	✓	✓	✓	✓	✓
***715FG	715x497mm, clear glazed	✓	✓	✓	✓	✓	✓
***895FG	895x497mm, clear glazed	✓	✓	✓	✓	✓	✓

KEY INFORMATION

Frontal Prefix Codes
Stocked - **FSO**
Paint-to-order - **FXO**

X The following frontal sizes from stocked Fitzroy are not available in Fitzroy Edge

***116 115x597mm (slab)

***715X257 715x257mm

***CD716 715x300mm, Small Curved Door



*Subject to capacity



Fitzroy Edge Slate shown with Antique Bronze backplate

FITZROY EDGE

KITCHEN FASCIA MATRIX FOR LAY-ON DOORS

This matrix can be referred to when planning a design in Fitzroy Edge. The matrix illustrates recommended configurations and Edge handle locations, based on stocked sizes from the Fitzroy range. Please reference page 86-88 for 'Handle Location Guide'.

TALL HEIGHT INSTALLATION

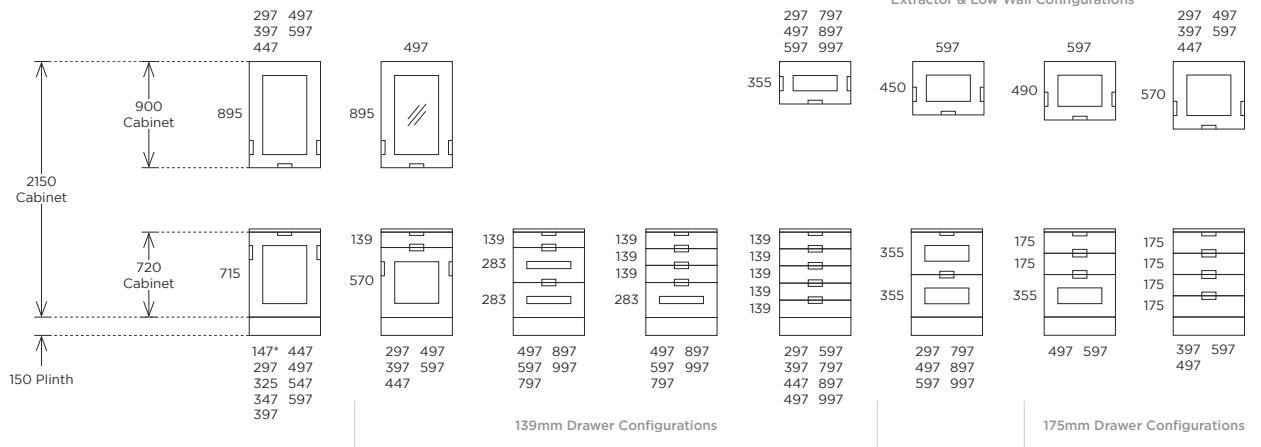

MEDIUM HEIGHT INSTALLATION

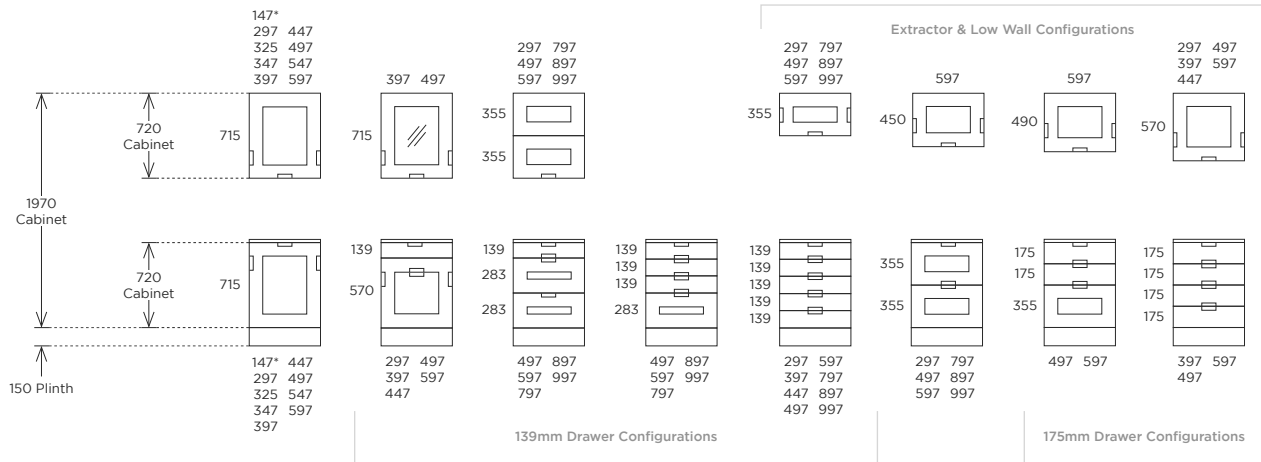

LOW HEIGHT INSTALLATION

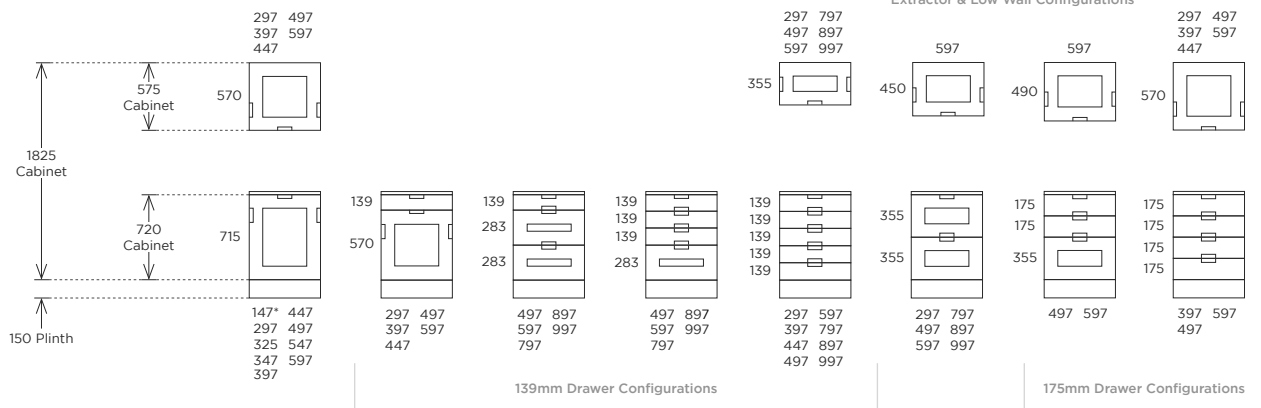

HANDLE LOCATION

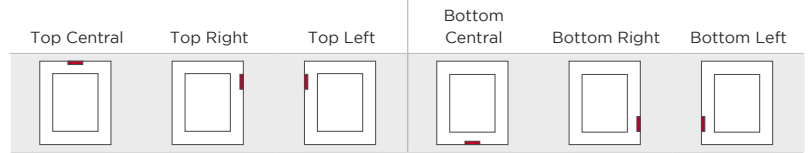

Recommended handle locations are illustrated on the doors below.

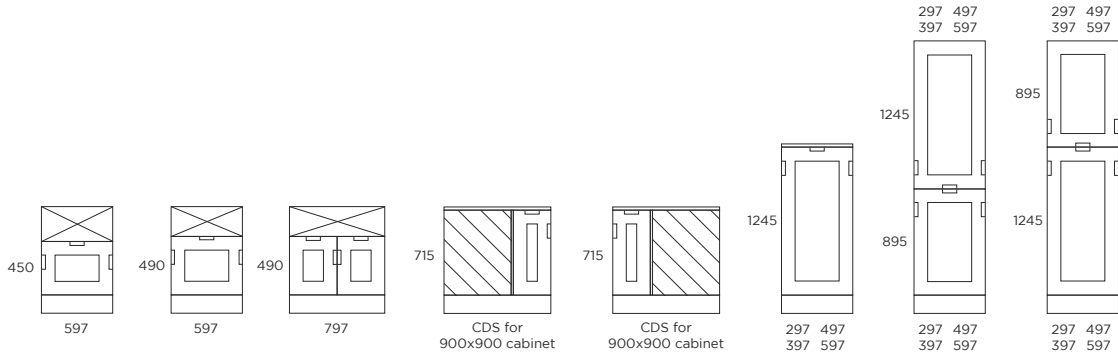

Ceramic Sink Configurations

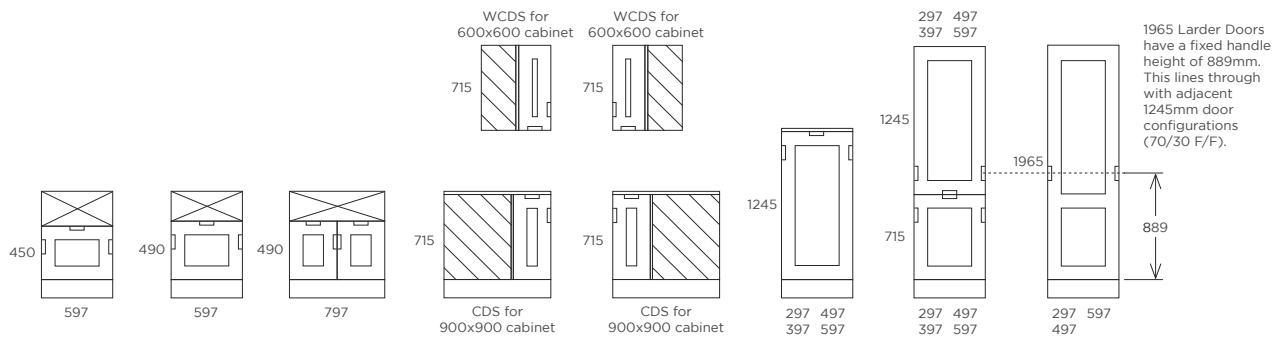

Ceramic Sink Configurations

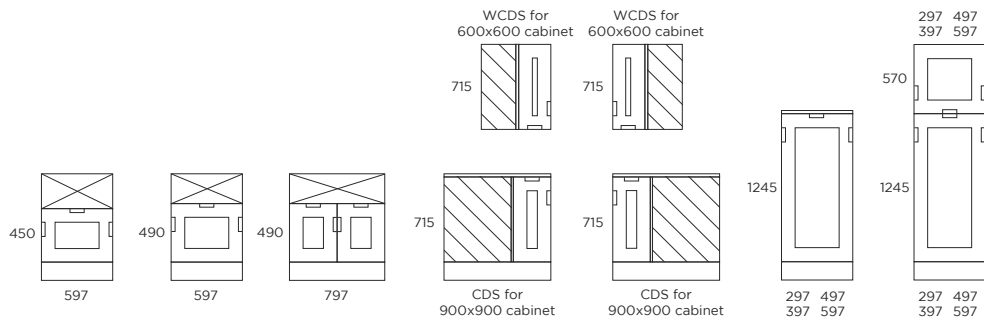

Ceramic Sink Configurations

Please note
*Not all handle locations available (please see 'Handle Location Guide' for more information)

FITZROY EDGE

KITCHEN APPLIANCE MATRIX FOR LAY-ON DOORS

This matrix can be referred to when planning built-in appliance housings in Fitzroy Edge. The matrix illustrates industry standard configurations and Edge handle locations, based on stocked sizes from the Fitzroy range. Whilst the majority of these configurations eradicates the need for fillers, there are a few instances where a filler is required (see in matrix).

Please note: Aperture sizes shown with the actual appliance size shown below in brackets.

TALL HEIGHT INSTALLATION

To be used with 600mm wide appliances

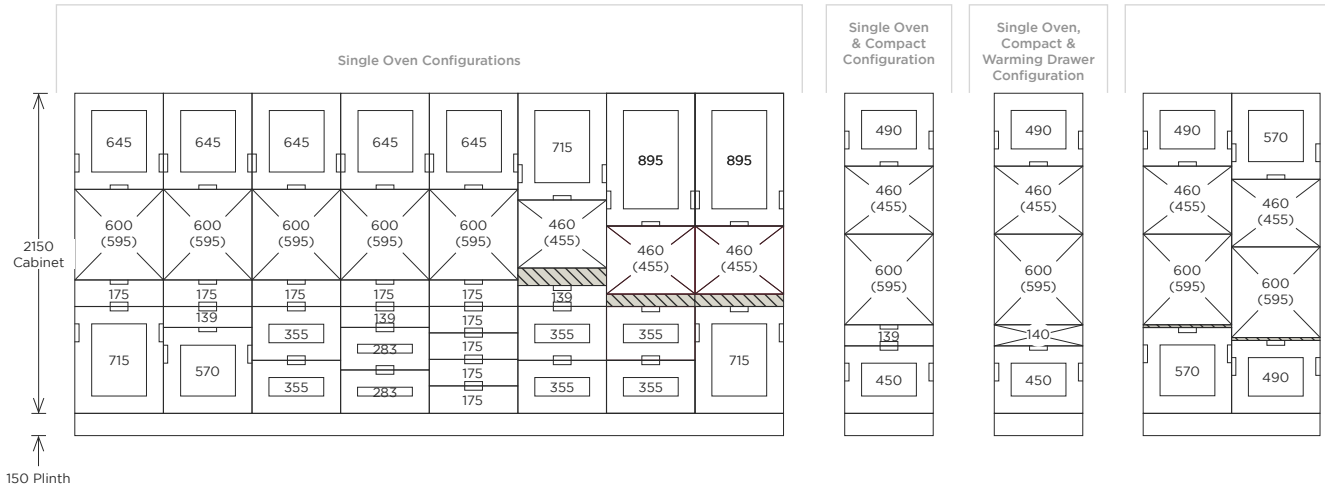

MEDIUM HEIGHT INSTALLATION

To be used with 600mm wide appliances

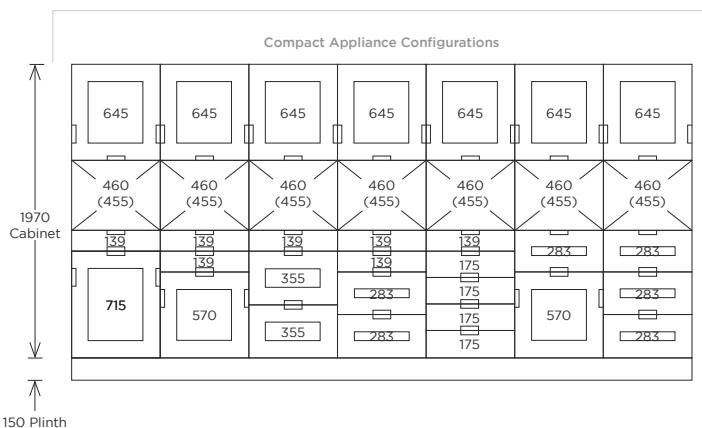
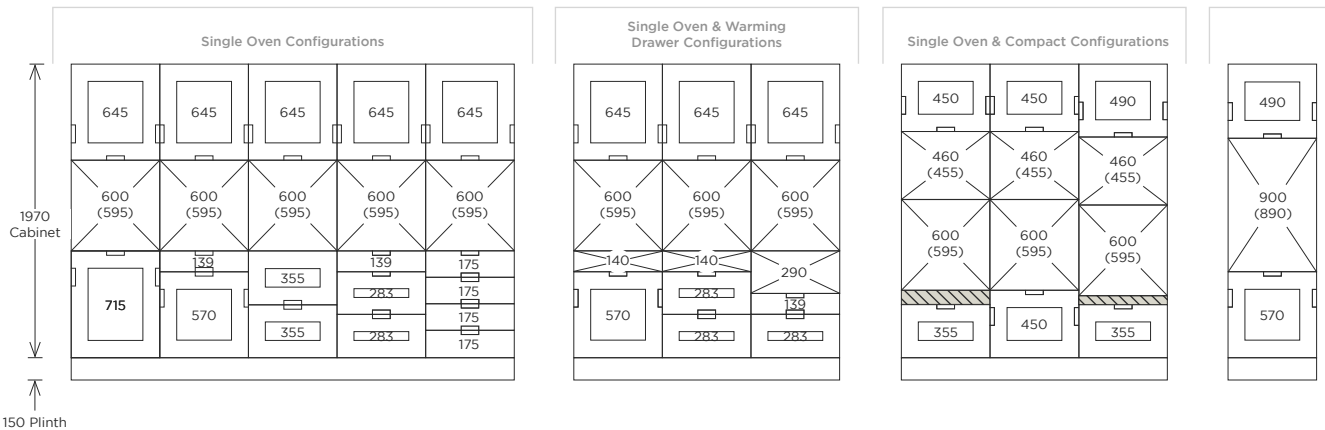

HANDLE LOCATION

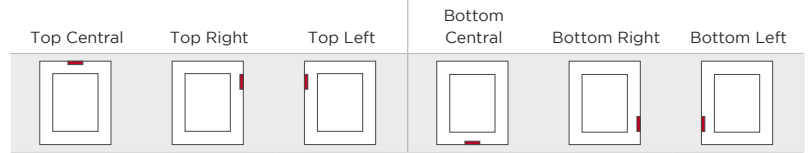

Recommended handle locations are illustrated on the doors below.

 Filler Required

Single Oven & Microwave or Coffee Machine Configurations

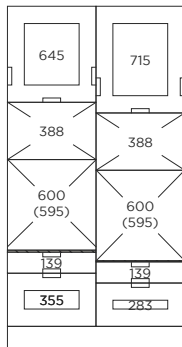

Double Oven Configurations

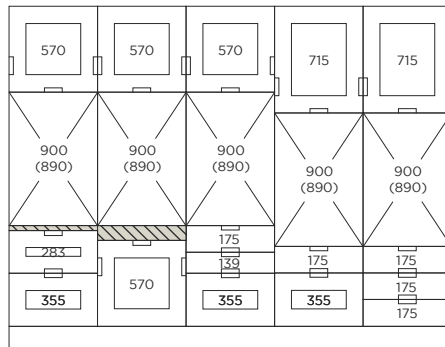

Fridge/Freezer Configurations

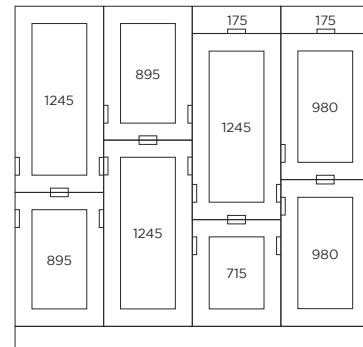

Please note:
For Fridge/
Freezer Doors it is
recommended to use
Right or Left
handle locations.

Double Oven Configurations

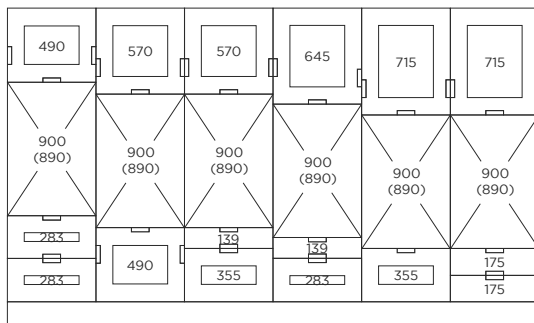

Compact & Warming Drawer Configurations

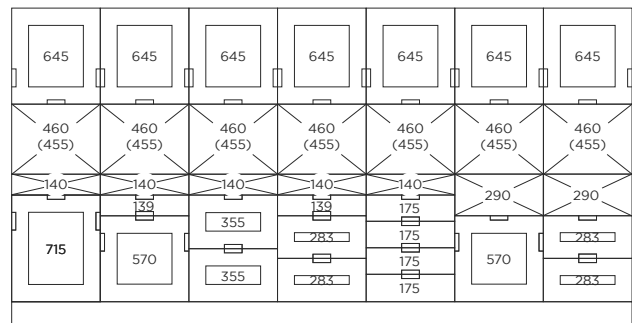

Fridge/Freezer Configurations

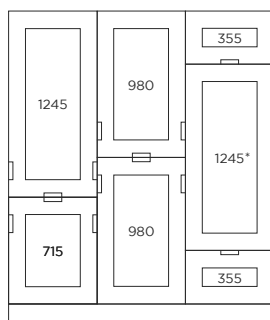

Please note:
For Fridge/
Freezer Doors it is
recommended to use
Right or Left
handle locations.

Please note:
* Mounted handle
recommended on
configuration

Please note:

- Specialist appliance brands such as Miele, Sub Zero and Wolf adopt a different size matrix.
- If fillers must be used, typically a 139 x 597mm drawer front or 115 x 597mm oven trimmer are the most recommended products. Cut to size along the length to suit the void, and finish the raw edge using a PWS touch up kit.

Please note
*Not all handle locations available (please see 'Handle Location Guide' for more information)

CRATHORNE EDGE



Available in
Kitchens



Available in
Home Office

A contemporary twist on the traditional Shaker style. Featuring an elegant narrow frame design, and a distinctive ash grain texture, Crathorne lends itself perfectly to both classic and contemporary kitchen looks.

1 HANDLE OPTION AVAILABLE

Pick your backplate finish -
8 options available

Pick your frontal colour -
35 colours to choose from

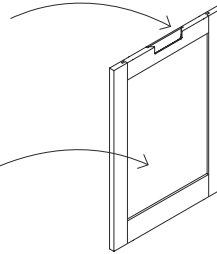

EDGE
Page 96



EDGE

Example shown - Crathorne Edge,
Frontal: Bay Green, Backplate: Aged Brass



EDGE

Example shown - Crathorne Edge,
Frontal: Georgian Red, Backplate: Matching



EDGE

Example shown - Crathorne Edge,
Frontal: Porcelain, Backplate: Carbon



EDGE

Example shown - Crathorne Edge,
Frontal: Graphite, Backplate: Brushed Brass

FRONTAL COLOURS

STOCKED COLOURS - PREFIX CSO

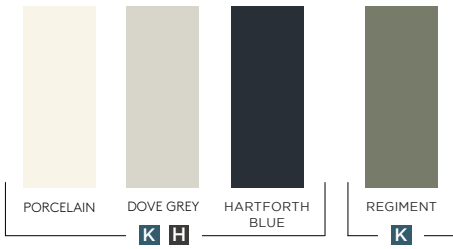

K Available in Kitchens
H Available in Home Office

PAINT-TO-ORDER COLOURS - PREFIX CXO

NEUTRALS

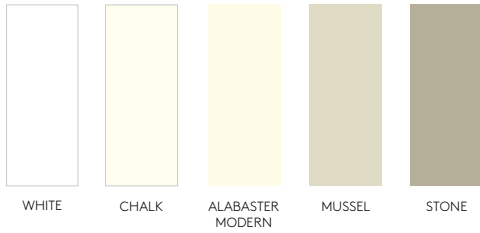

GREYS



WARM NEUTRALS

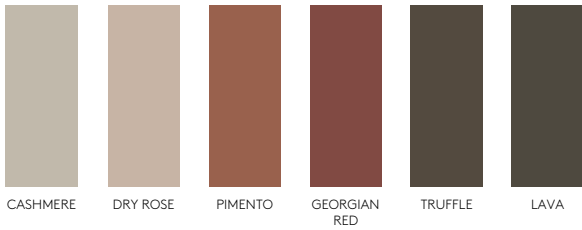

OLIVE GREENS

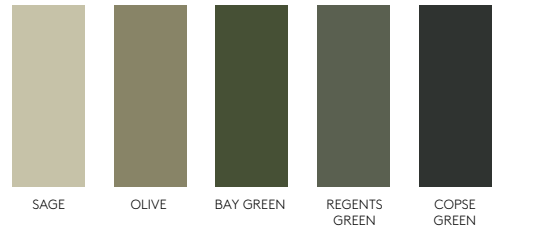

FOREST GREENS

GREEN BLUES

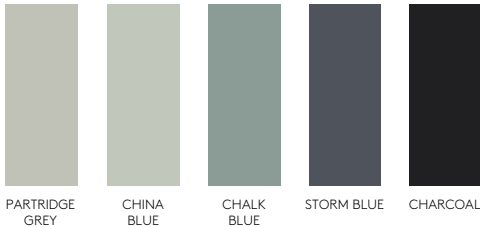

INK BLUES

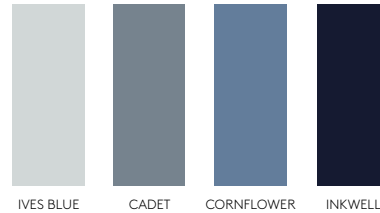

BACKPLATE FINISHES

TIMBER BACKPLATES (4mm)



METALLIC BACKPLATES (2mm)



PAINTED BACKPLATES (4mm)

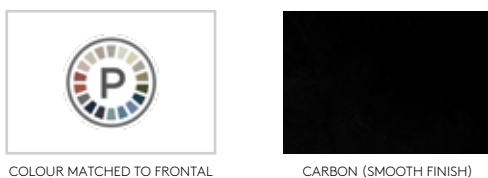

CRATHORNE EDGE



Door Drilling Service



Painted Finish



6 Year Guarantee

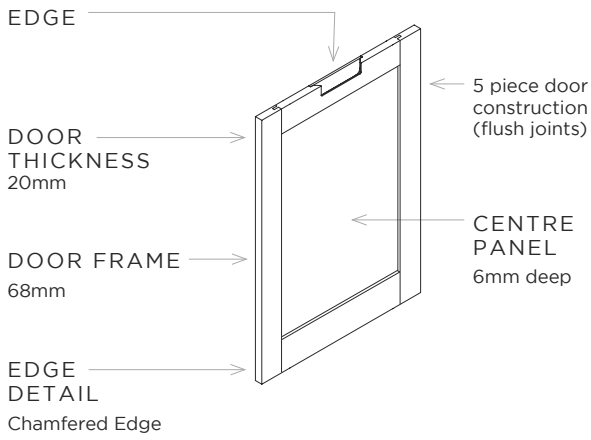

CRATHORNE SPECIFICATION

DOOR FAMILY STYLE	Narrow framed Shaker - 5 piece construction with flush joints
DOOR THICKNESS	20mm
SUBSTRATE	Solid Ash frame with Ash veneered MDF centre panel
FINISH	Matt painted (grained finish)
REVERSE	Painted as per front (Sanded is unfinished)
CERTIFICATION	Fira Gold

HANDLE LOCATION

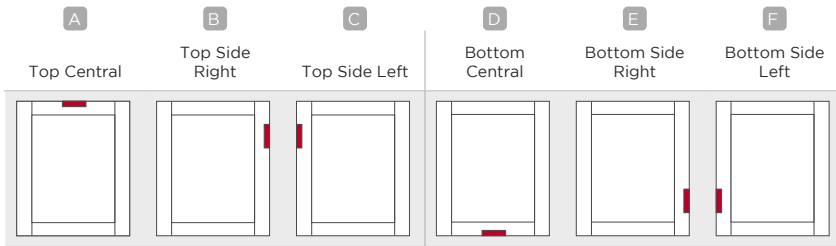

Note: This does not apply to 1965 Larder Doors. Please see page 100 for fixed handle height and lining through details.

HANDLE SPECIFICATION

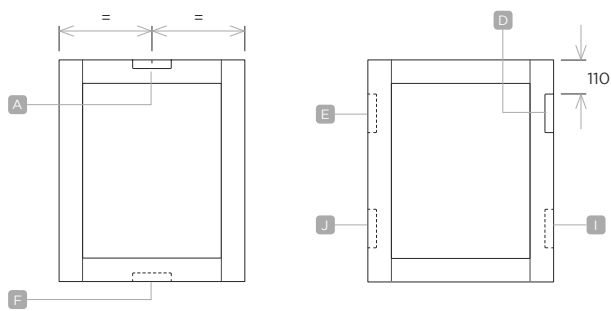

ROUTER SPECIFICATION

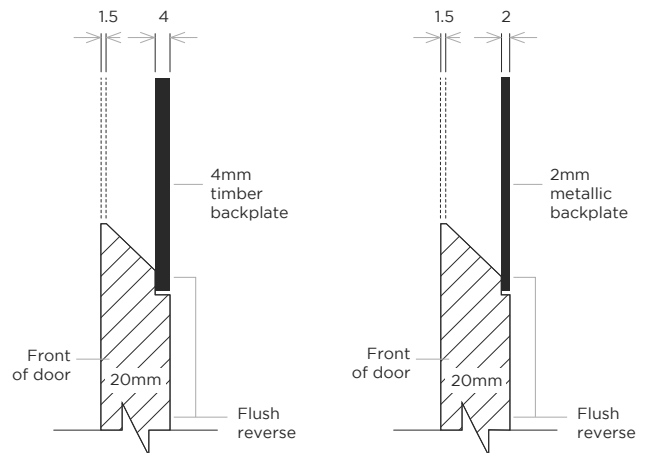

Note: For a flush reverse, doors are processed accordingly, to accommodate metallic and timber backplates.



Crathorne Edge shown in Bay Green with Aged Brass backplate

CRATHORNE EDGE

code	(HxW)	Top Central	Bottom Central
Drawer fronts			
***143	139x297mm	✓	✓
***144	139x397mm	✓	✓
***139X447	139x447mm	✓	✓
***145	139x497mm	✓	✓
***146	139x597mm	✓	✓
***148	139x797mm	✓	✓
***149	139x897mm	✓	✓
***140	139x997mm	✓	✓
***175	175x497mm	✓	✓
***176	175x597mm	✓	✓

KEY INFORMATION

Frontal Prefix Codes
 Stocked - **CSO**
 Paint-to-order - **CXO**

X The following frontal sizes from stocked Crathorne are not available in Crathorne Edge

***116 115x597mm (slab)
 ***715x257 715x257mm







*Subject to capacity

		Top Central	Top Side Right	Top Side Left	Bottom Central	Bottom Side Right	Bottom Side Left
Drawer fronts							
***285	283x497mm	✓	-	-	✓	-	-
***286	283x597mm	✓	-	-	✓	-	-
***288	283x797mm	✓	-	-	✓	-	-
***289	283x897mm	✓	-	-	✓	-	-
***280	283x997mm	✓	-	-	✓	-	-
***355	355x497mm	✓	✓	✓	✓	✓	✓
***356	355x597mm	✓	✓	✓	✓	✓	✓
***358	355x797mm	✓	-	-	✓	-	-
***359	355x897mm	✓	-	-	✓	-	-
***350	355x997mm	✓	-	-	✓	-	-

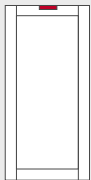
		Top Central	Top Side Right	Top Side Left	Bottom Central	Bottom Side Right	Bottom Side Left
Doors							
***456	450x597mm	✓	✓	✓	✓	✓	✓
***494	490x397mm, double farmhouse door	✓	✓	✓	✓	✓	✓
***496	490x597mm, farmhouse door	✓	✓	✓	✓	✓	✓
***573	570x297mm	✓	✓	✓	✓	✓	✓
***574	570x397mm	✓	✓	✓	✓	✓	✓
***570X447	570x447mm	✓	✓	✓	✓	✓	✓
***575	570x497mm	✓	✓	✓	✓	✓	✓
***576	570x597mm	✓	✓	✓	✓	✓	✓
***646	645x597mm	✓	✓	✓	✓	✓	✓
***715X147	715x147mm (slab)	-	✓	✓	-	✓	✓
***713	715x297mm	-	✓	✓	-	✓	✓
***715X325	715x325mm	✓	✓	✓	✓	✓	✓
***715X347	715x347mm	✓	✓	✓	✓	✓	✓
***714	715x397mm	✓	✓	✓	✓	✓	✓
***715X447	715x447mm	✓	✓	✓	✓	✓	✓
***715	715x497mm	✓	✓	✓	✓	✓	✓
***715X547	715x547mm	✓	✓	✓	✓	✓	✓
***716	715x597mm	✓	✓	✓	✓	✓	✓
Doors							
***896NC	895x597mm, (no cross rail)	-	-	-	✓	✓	✓
***986	980x597mm	✓	✓	✓	✓	✓	✓
***826	825x597mm with cross rail	-	-	-	✓	✓	✓
***893	895x297mm with cross rail	-	-	-	-	✓	✓
***894	895x397mm with cross rail	-	-	-	✓	✓	✓
***895X447	895x447mm with cross rail	-	-	-	✓	✓	✓
***895	895x497mm with cross rail	-	-	-	✓	✓	✓
***896	895x597mm with cross rail	-	-	-	✓	✓	✓

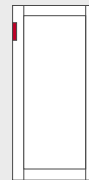
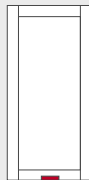
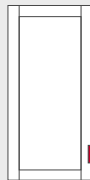



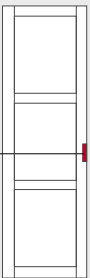
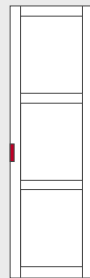

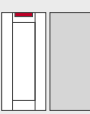
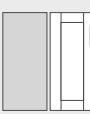
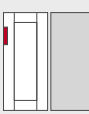
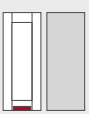
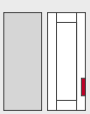
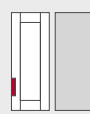
CRATHORNE EDGE

		Top Central	Top Side Right	Top Side Left	Bottom Central	Bottom Side Right	Bottom Side Left
Larder doors							
***123	1245x297mm	-	✓	✓	-	✓	✓
***124	1245x397mm	✓	✓	✓	✓	✓	✓
***125	1245x497mm	✓	✓	✓	✓	✓	✓
***126	1245x597mm	✓	✓	✓	✓	✓	✓
***1425X297	1425x297mm with cross rail	-	-	-	-	✓	✓
***1425X597	1425x597mm with cross rail	-	-	-	✓	✓	✓

		Fixed Right	Fixed Left
Tall larder doors			
<p>Note: • 1965 Larder Doors have a fixed handle height of 889mm. This lines through with adjacent 1245mm door configurations (70/30 F/F). • Larder doors are handed</p> <p>889 Fixed</p>			
***193	1965x297mm, (3 panel design, with 2 cross rails)	✓	✓
***196	1965x597mm, (3 panel design, with 2 cross rails)	✓	✓

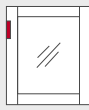
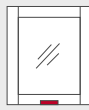
		Top Central	Top Side Right	Top Side Left	Bottom Central	Bottom Side Right	Bottom Side Left
Corner Doors							
***WCDS	715x277x18mm Wall corner door solution, (pair)	-	-	-	-	✓	✓
***CDS	715x315x18mm corner door solution, (pair)	✓	✓	✓	-	-	-

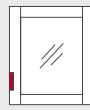
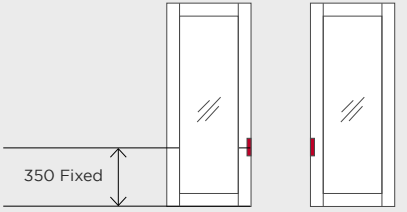
Note: Corner doors come as a pair. Handle features on one door only.

		Top Central	Top Side Right	Top Side Left	Bottom Central	Bottom Side Right	Bottom Side Left
Glazed doors - clear glazed							
***714CG	715x397mm, clear glazed	✓	✓	✓	✓	✓	✓
***715CG	715x497mm, clear glazed	✓	✓	✓	✓	✓	✓
							
***1215X497CG	1215x497mm, clear glazed dresser					✓	✓
							
***895CG	895x497mm, clear glazed with cross rail				✓	✓	✓

KEY INFORMATION

Frontal Prefix Codes
Stocked - **CSO**
Paint-to-order - **CXO**

X The following frontal sizes from stocked Crathorne are not available in Crathorne Edge

***116 115x597mm (slab)

***715x257 715x257mm



*Subject to capacity

CRATHORNE EDGE

KITCHEN FASCIA MATRIX FOR LAY-ON DOORS

This matrix can be referred to when planning a design in Crathorne Edge. The matrix illustrates recommended configurations and Edge handle locations, based on stocked sizes from the Crathorne range. Please reference page 98-101 for 'Handle Location Guide'.

TALL HEIGHT INSTALLATION

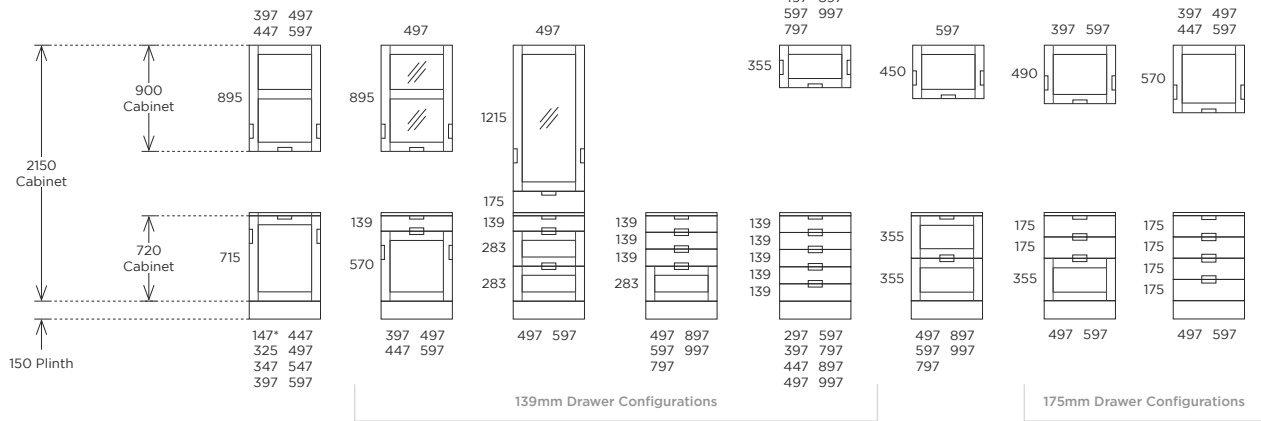

MEDIUM HEIGHT INSTALLATION

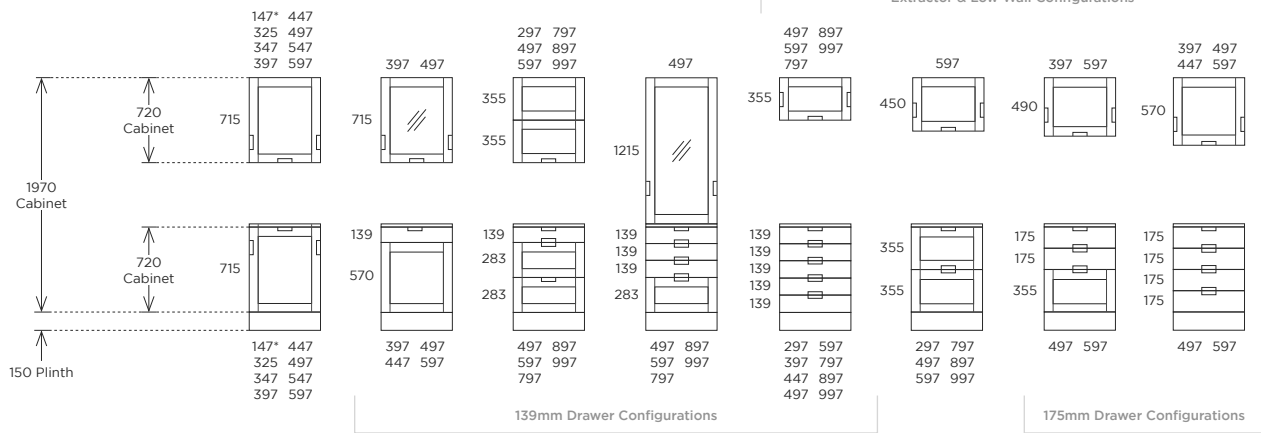

LOW HEIGHT INSTALLATION

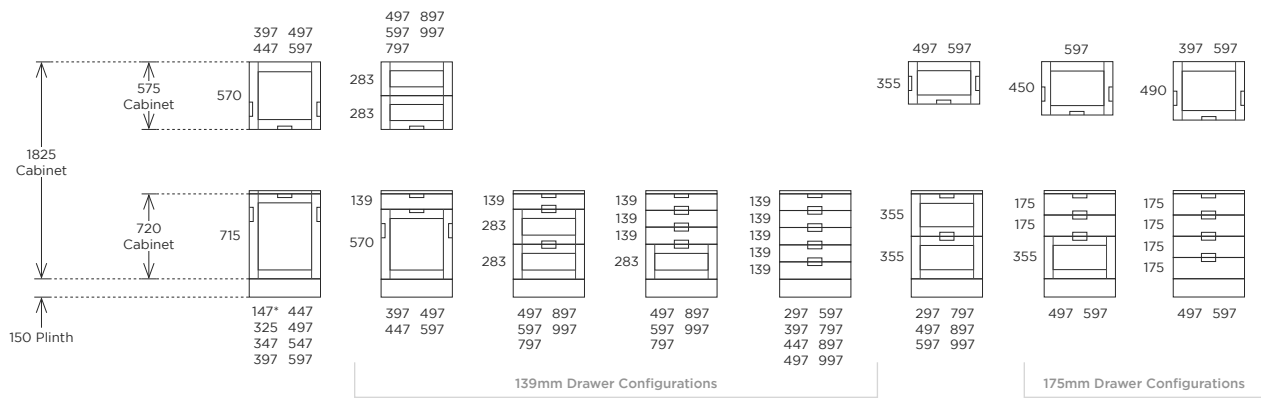

HANDLE LOCATION

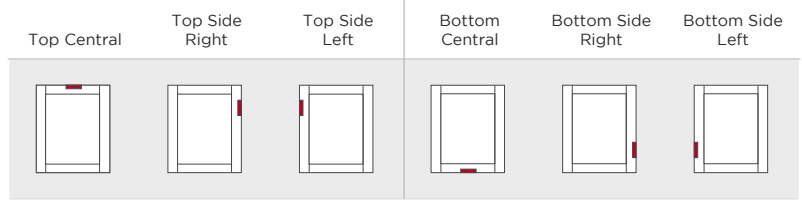

Recommended handle locations are illustrated on the doors below.

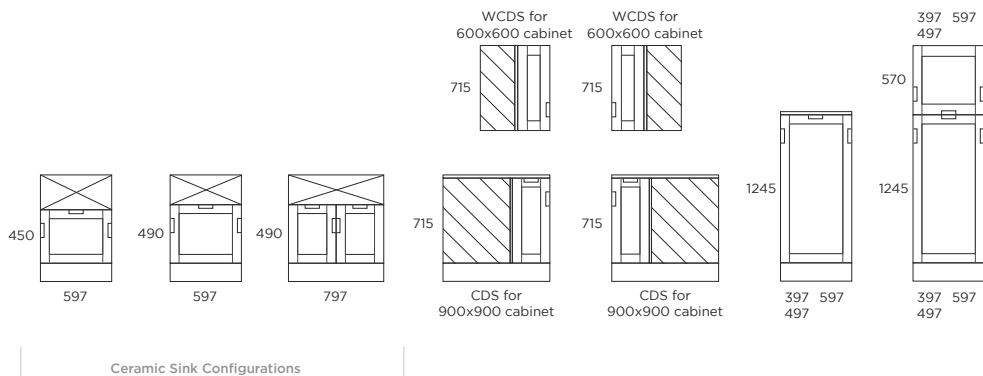
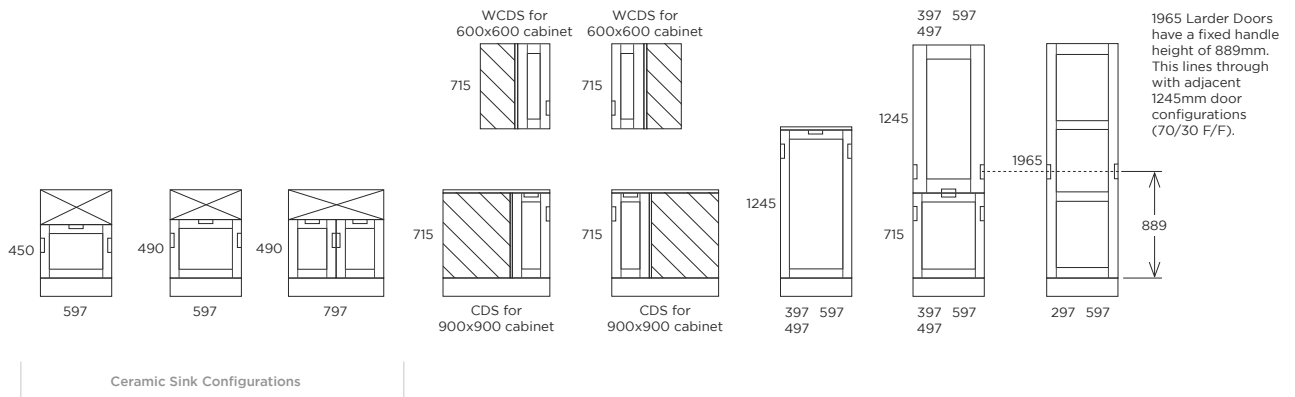
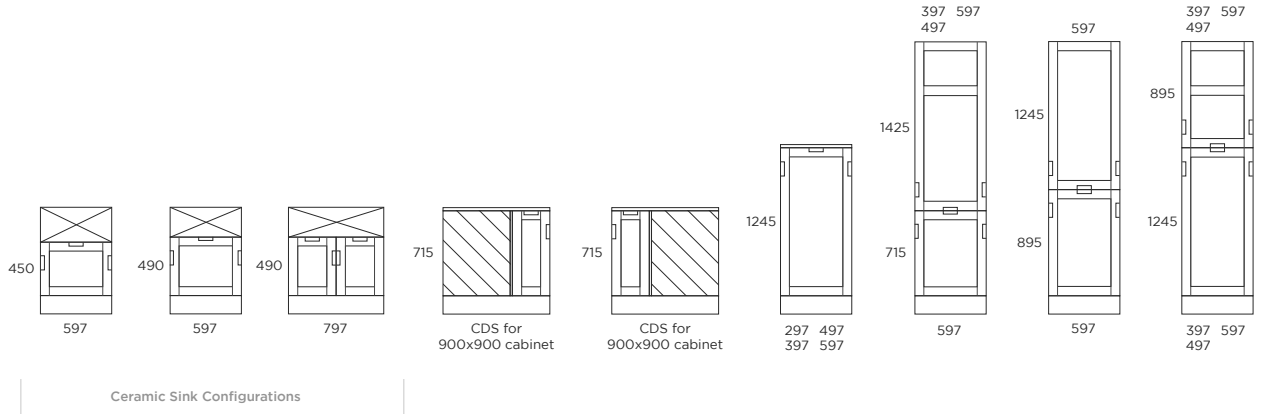

Please note
*Not all handle locations available (please see 'Handle Location Guide' for more information)

CRATHORNE EDGE

KITCHEN APPLIANCE MATRIX FOR LAY-ON DOORS

This matrix can be referred to when planning built-in appliance housings in Crathorne Edge. The matrix illustrates industry standard configurations and Edge handle locations, based on stocked sizes from the Crathorne range. Whilst the majority of these configurations eradicates the need for fillers, there are a few instances where a filler is required (see in matrix).

Please note: Aperture sizes shown with the actual appliance size shown below in brackets.

TALL HEIGHT INSTALLATION

To be used with 600mm wide appliances

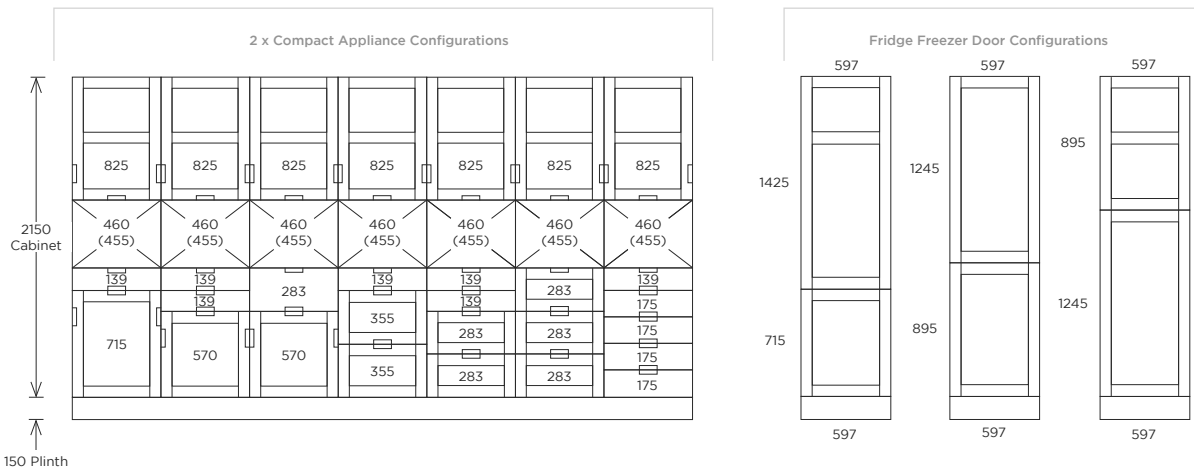
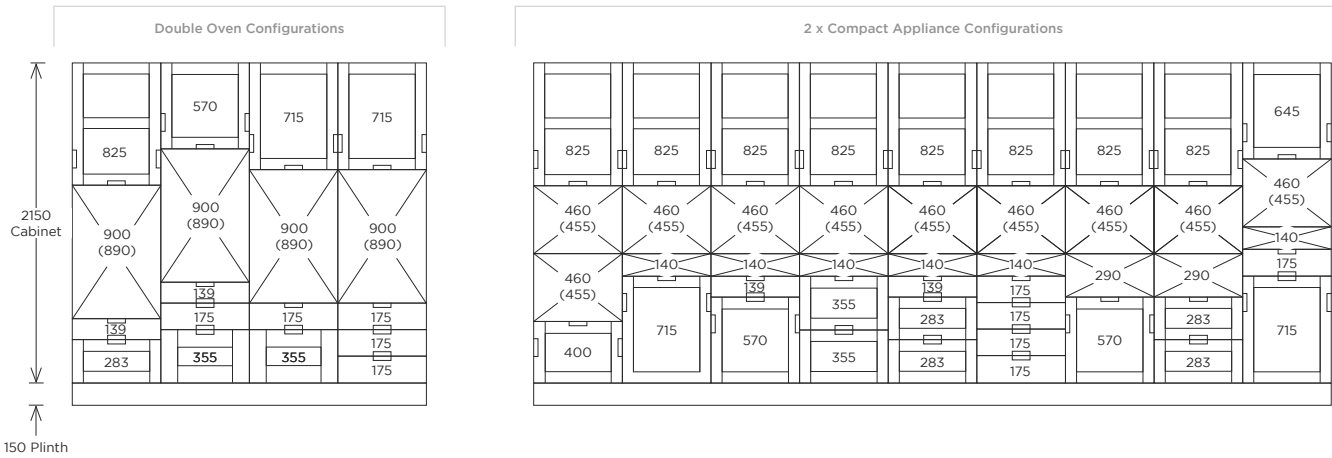
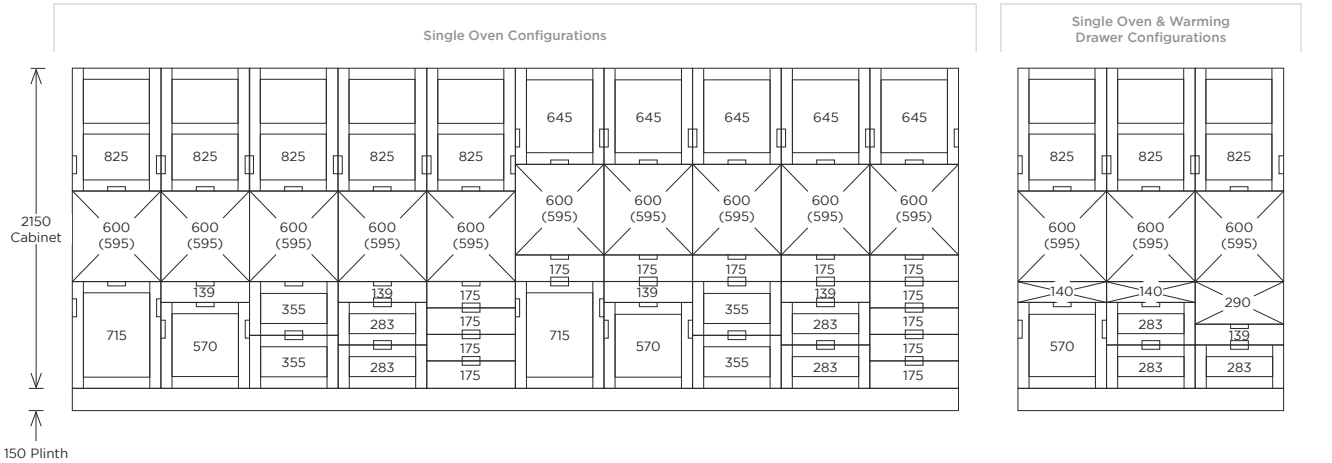

HANDLE LOCATION

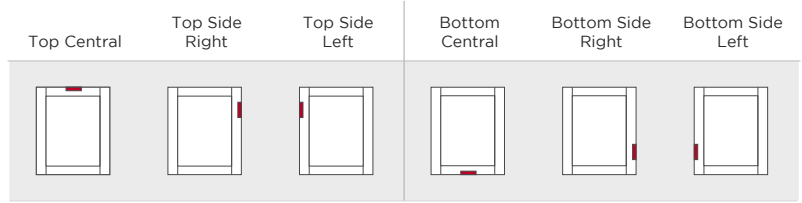

Recommended handle locations are illustrated on the doors below.

Single Oven & Compact Configurations

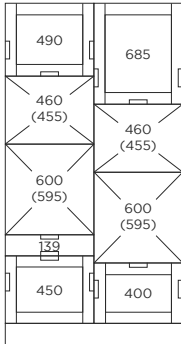

Single Oven, Compact & Warming Drawer Configuration

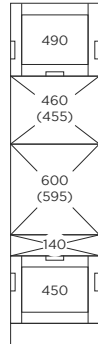

Single Oven & Microwave or Coffee Machine Configurations

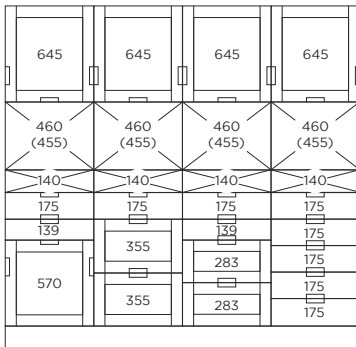
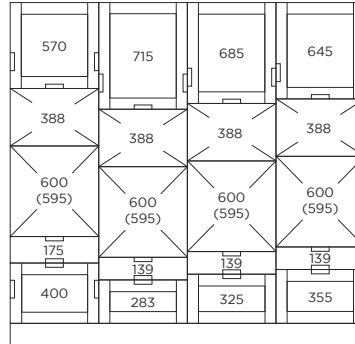

Please note
*Not all handle locations available (please see 'Handle Location Guide' for more information)

CRATHORNE EDGE

KITCHEN APPLIANCE MATRIX FOR LAY-ON DOORS

This matrix can be referred to when planning built-in appliance housings in Crathorne Edge. The matrix illustrates industry standard configurations and Edge handle locations, based on stocked sizes from the Crathorne range. Whilst the majority of these configurations eradicates the need for fillers, there are a few instances where a filler is required (see in matrix).

Please note: Aperture sizes shown with the actual appliance size shown below in brackets.

MEDIUM HEIGHT INSTALLATION

To be used with 600mm wide appliances

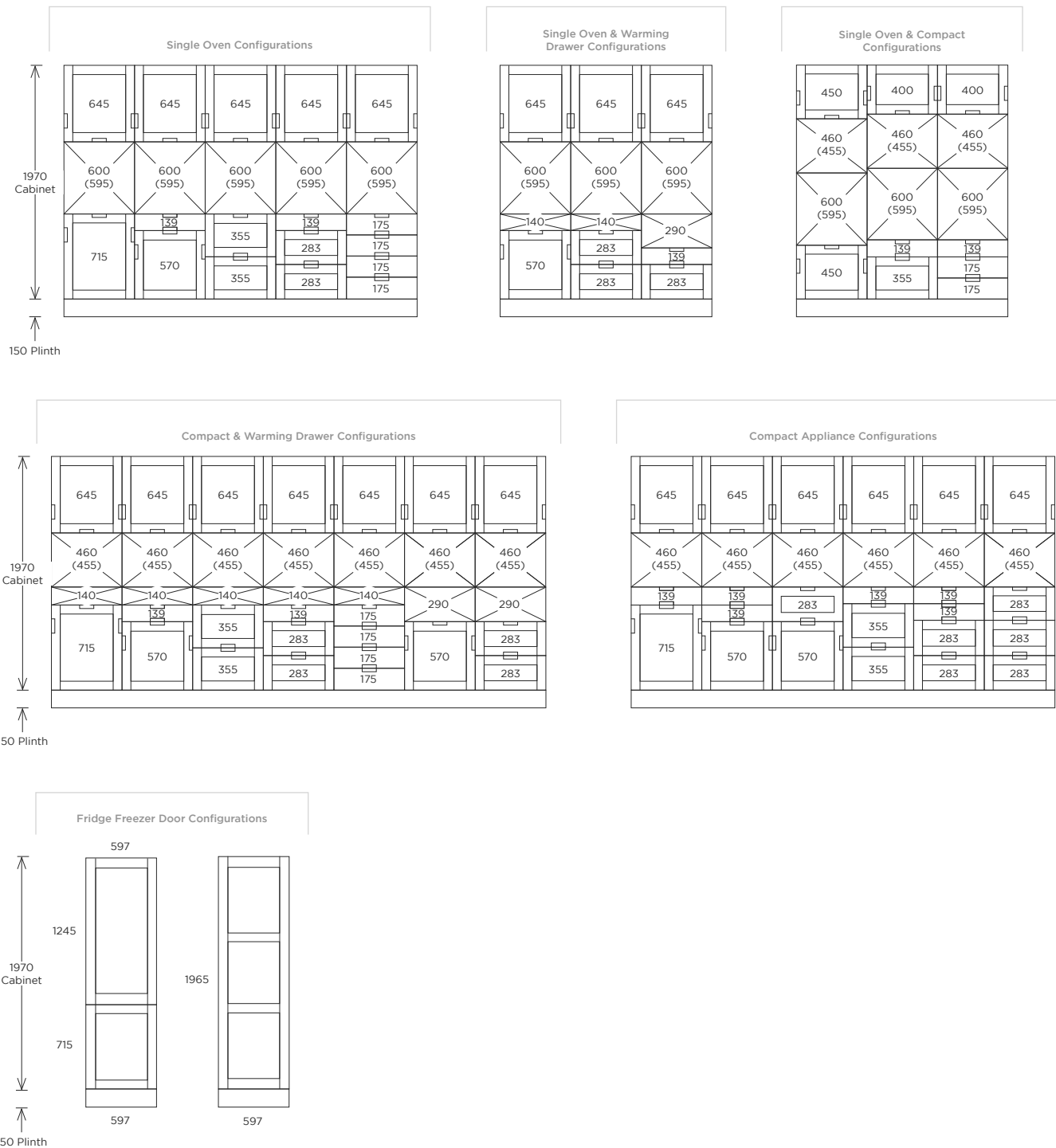

HANDLE LOCATION

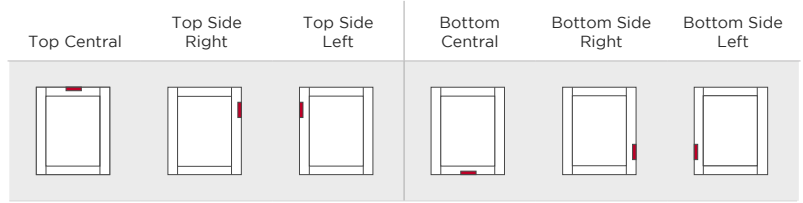

Recommended handle locations are illustrated on the doors below.

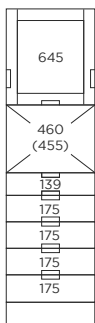
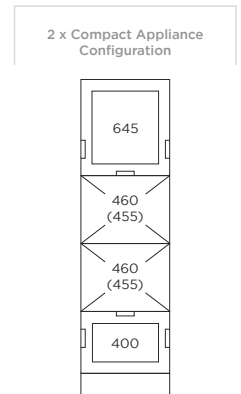
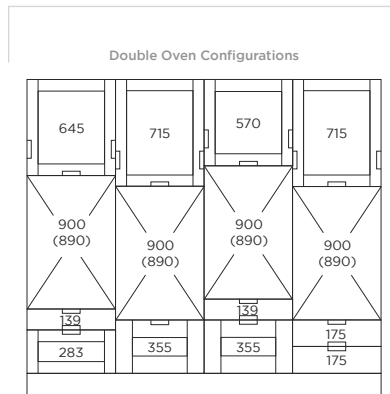
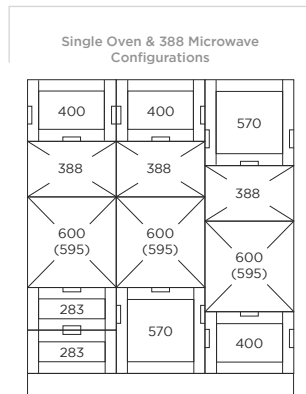
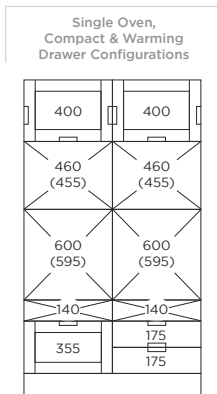

Please note
*Not all handle locations available (please see 'Handle Location Guide' for more information)

MORNINGTON SHAKER



Available in
Kitchens



Available in
Home Office

Our best-selling Shaker family features a 5-piece real timber construction, narrow frame design and distinctive ash grain texture.

1 HANDLE OPTION AVAILABLE

Pick your backplate finish -
8 options available

Pick your frontal colour -
35 colours to choose from

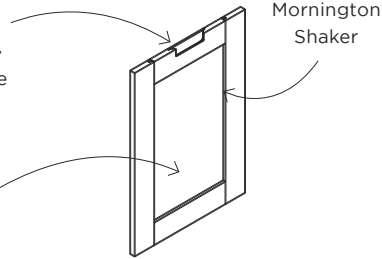

EDGE
Page 110



EDGE

Example shown - Mornington Shaker Edge,
Frontal: Cadet, Backplate: Matching



EDGE

Example shown - Mornington Shaker Edge,
Frontal: Dust Grey, Backplate: Carbon



EDGE

Example shown - Mornington Shaker Edge,
Frontal: Georgian Red, Backplate: Bright Copper



EDGE

Example shown - Mornington Shaker Edge,
Frontal: Copse Green, Backplate: Matching

FRONTAL COLOURS

STOCKED COLOURS - PREFIX MGSO

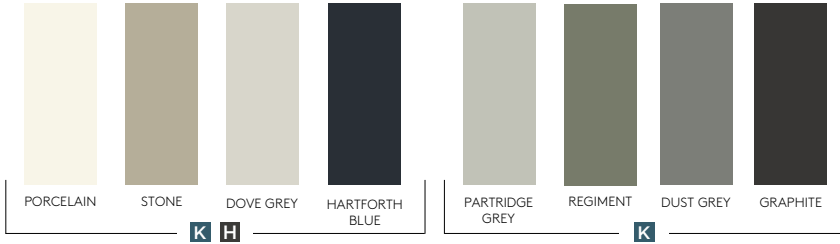

K Available in Kitchens
H Available in Home Office

PAINT-TO-ORDER COLOURS - PREFIX MGXO

NEUTRALS

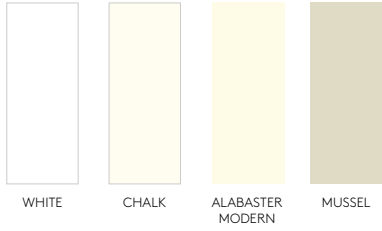

GREYS



WARM NEUTRALS

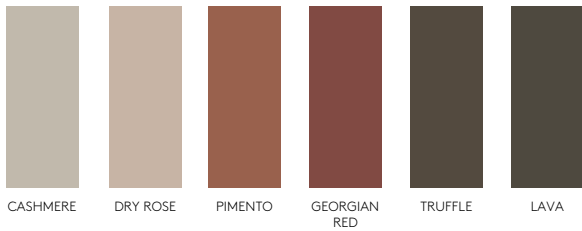

OLIVE GREENS

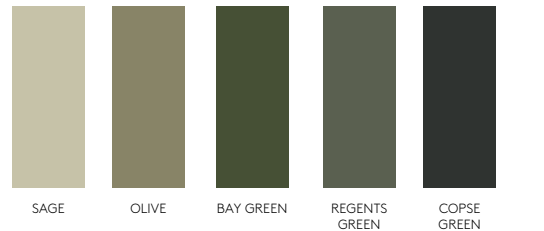

GREEN BLUES

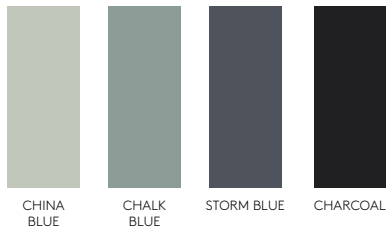

INK BLUES

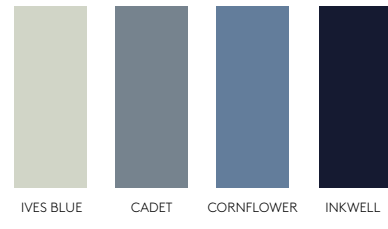

BACKPLATE FINISHES

TIMBER BACKPLATES (4mm)



METALLIC BACKPLATES (2mm)



PAINTED BACKPLATES (4mm)

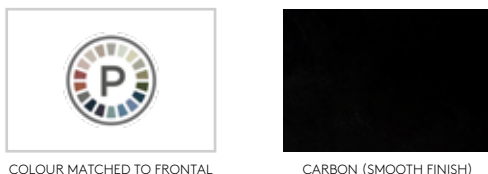

MORNINGTON SHAKER EDGE

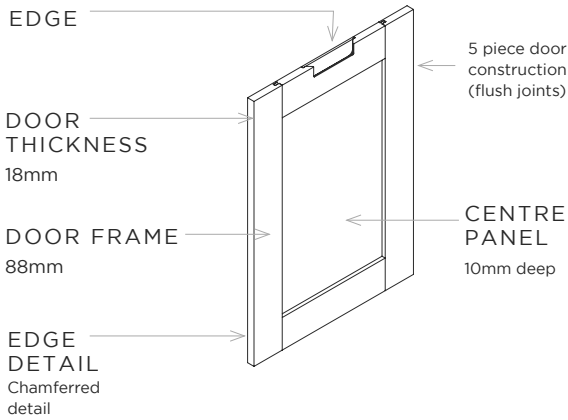

MORNINGTON SPECIFICATION

DOOR FAMILY STYLE	Shaker - 5 piece construction with flush joints
DOOR THICKNESS	20mm
SUBSTRATE	Solid Ash frame with Ash veneered MDF centre panel
FINISH	Matt Painted (grained finish)
REVERSE	Painted as per front face
CERTIFICATION	Fira Gold

HANDLE LOCATION

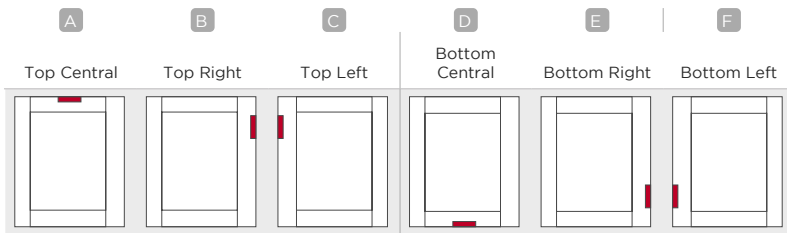

Note: This does not apply to 1965 Larder Doors.
Please see page 117 for fixed handle height and lining through details.

HANDLE SPECIFICATION

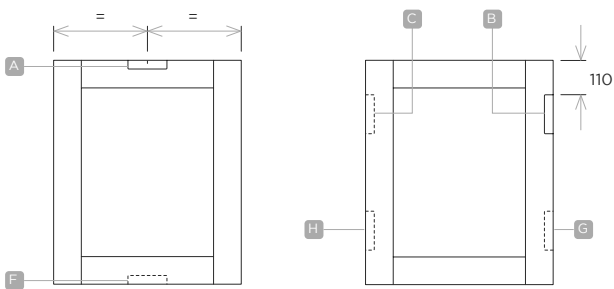

ROUTER SPECIFICATION

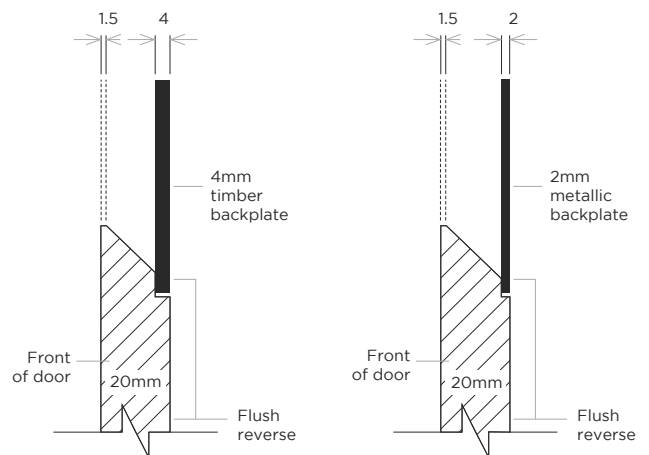

4mm TIMBER BACKPLATES

2mm METALLIC BACKPLATES

Note: For a flush reverse, doors are processed accordingly, to accommodate metallic and timber backplates.



Mornington Shaker Regents Green shown with Oak backplates

MORNINGTON BEADED



Available in
Kitchens



Available in
Bedrooms



Available in
Home Office

An evolution of our in-demand Shaker, Mornington Beaded offers the same features and benefits but with the additional of a decorative quarter round beading detail.

1 HANDLE OPTION AVAILABLE

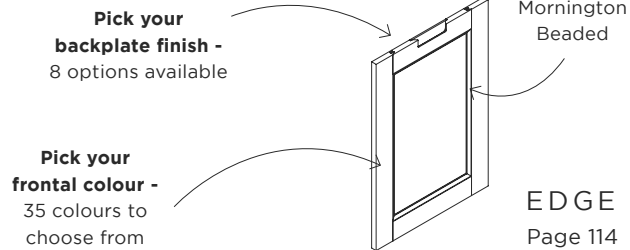

EDGE

Example shown - Mornington Beaded Edge,
Frontal: Porcelain, Backplate: Bright Copper



EDGE

Example shown - Mornington Beaded Edge,
Frontal: Inkwell, Backplate: Aged Brass



EDGE

Example shown - Mornington Beaded Edge,
Frontal: Dove Grey, Backplate: Matching



EDGE

Example shown - Mornington Beaded Edge,
Frontal: Storm Blue, Backplate: Carbon

MORNINGTON BEADED EDGE

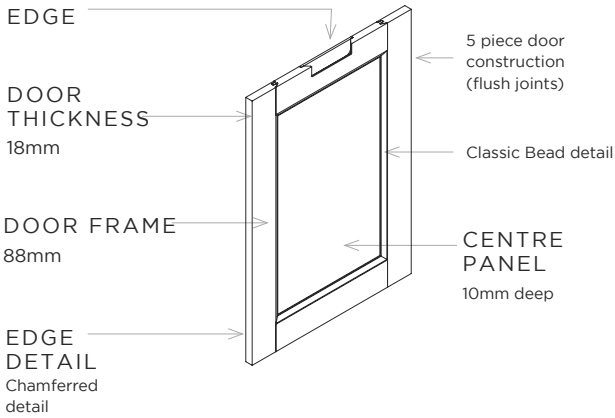

MORNINGTON SPECIFICATION

DOOR FAMILY STYLE	Shaker - 5 piece construction with flush joints
DOOR THICKNESS	20mm
SUBSTRATE	Solid Ash frame with Ash veneered MDF centre panel
FINISH	Matt Painted (grained finish)
REVERSE	Painted as per front face
CERTIFICATION	Fira Gold

HANDLE LOCATION

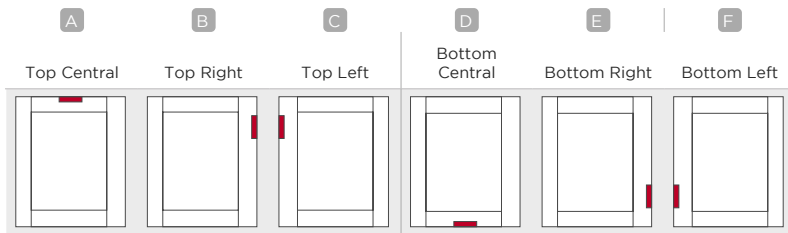

Note: This does not apply to 1965 Larder Doors.
Please see page 117 for fixed handle height and lining through details.

HANDLE SPECIFICATION

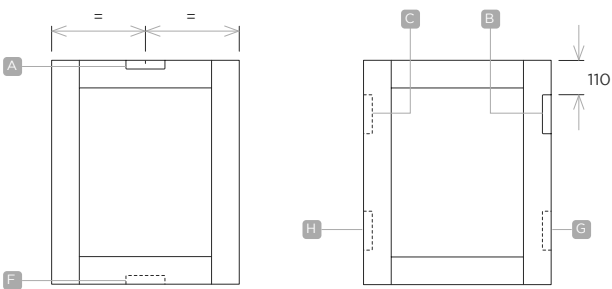

ROUTER SPECIFICATION

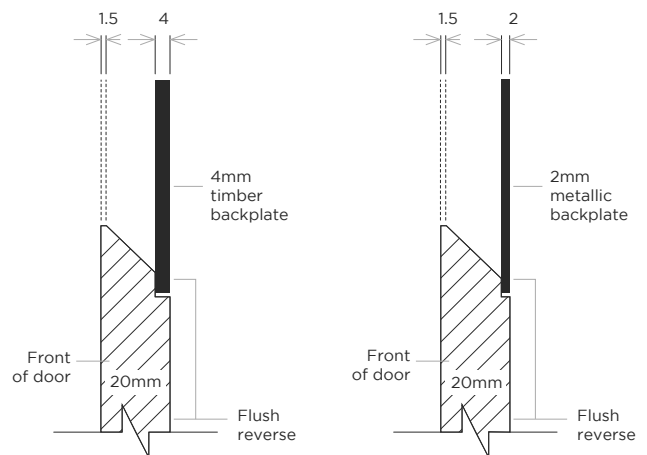

4mm TIMBER BACKPLATES



2mm METALLIC BACKPLATES

Note: For a flush reverse, doors are processed accordingly, to accommodate metallic and timber backplates.



Mornington Beaded Graphite (Base Units) and Putty (Wall Units) shown with Matching backplates

MORNINGTON SHAKER & BEADED EDGE

code	(HxW)	Top Central	Bottom Central
Drawer fronts			
***85x597	85x597mm		
***85x797	85x797mm	✓	-
***85x997	85x997mm	✓	-
***143	139x297mm	✓	✓
***144	139x397mm	✓	✓
***139X447	139x447mm	✓	✓
***145	139x497mm	✓	✓
***146	139x597mm	✓	✓
***148	139x797mm	✓	✓
***149	139x897mm	✓	✓
***140	139x997mm	✓	✓
***175	175x497mm	✓	✓
***176	175x597mm	✓	✓

KEY INFORMATION

Frontal Prefix Codes

Shaker
 Stocked - **MGSO**
 Paint-to-order - **MGXO**













Beaded
 Stocked - **MBSO**
 Paint-to-order - **MBXO**

X The following frontal sizes from stocked Mornington Shaker and Mornington Beaded are not available in Mornington Edge

***116 115x597mm (slab)
 ***715X257 715x257mm
 ***CD716 715x300mm, Small Curved Door



*Subject to capacity

		Top Central	Top Right	Top Left	Bottom Central	Bottom Right	Bottom Left
Drawer fronts							
							
***215x397	215x397mm	✓	-	-	✓	-	-
***215x497	215x497mm	✓	-	-	✓	-	-
***215x797	215x797mm	✓	-	-	✓	-	-
***215x997	215x997mm	✓	-	-	✓	-	-
***285	283x497mm	✓	-	-	✓	-	-
***286	283x597mm	✓	-	-	✓	-	-
***288	283x797mm	✓	-	-	✓	-	-
***289	283x897mm	✓	-	-	✓	-	-
***280	283x997mm	✓	-	-	✓	-	-
***355	355x497mm	✓	✓	✓	✓	✓	✓
***356	355x597mm	✓	✓	✓	✓	✓	✓
***358	355x797mm	✓	-	-	✓	-	-
***359	355x897mm	✓	-	-	✓	-	-
***350	355x997mm	✓	-	-	✓	-	-
Doors							
							
***447x397	447x397mm	✓	✓	✓	✓	✓	✓
***447x447	447x447mm	✓	✓	✓	✓	✓	✓
***447x597	447x597mm	✓	✓	✓	✓	✓	✓
***456	450x597mm	✓	✓	✓	✓	✓	✓
***494	490x397mm	✓	✓	✓	✓	✓	✓
***496	490x597mm	✓	✓	✓	✓	✓	✓
***573	570x297mm	-	✓	✓	-	✓	✓
***574	570x397mm	✓	✓	✓	✓	✓	✓
***570X447	570x447mm	✓	✓	✓	✓	✓	✓
***575	570x497mm	✓	✓	✓	✓	✓	✓
***576	570x597mm	✓	✓	✓	✓	✓	✓
***646	645x597mm	✓	✓	✓	✓	✓	✓

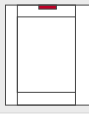
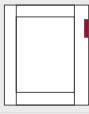
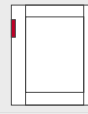
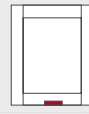
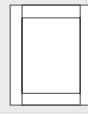
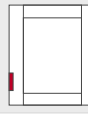
		Top Central	Top Right	Top Left	Bottom Central	Bottom Right	Bottom Left
Doors							
***715X147	715x147mm (slab)	-	✓	✓	-	✓	✓
***713	715x297mm	-	✓	✓	-	✓	✓
***715X325	715x325mm	-	✓	✓	-	✓	✓
***715X347	715x347mm	✓	✓	✓	✓	✓	✓
***714	715x397mm	✓	✓	✓	✓	✓	✓
***715X447	715x447mm	✓	✓	✓	✓	✓	✓
***715	715x497mm	✓	✓	✓	✓	✓	✓
***715X547	715x547mm	✓	✓	✓	✓	✓	✓
***716	715x597mm	✓	✓	✓	✓	✓	✓
***893	895x297mm	-	✓	✓	-	✓	✓
***894	895x397mm	✓	✓	✓	✓	✓	✓
***895X447	895x447mm	✓	✓	✓	✓	✓	✓
***895	895x497mm	✓	✓	✓	✓	✓	✓
***896	895x597mm	✓	✓	✓	✓	✓	✓
***986	980x597mm	✓	✓	✓	✓	✓	✓
Larder doors							
***123	1245x297mm	-	✓	✓	-	✓	✓
***124	1245x397mm	✓	✓	✓	✓	✓	✓
***125	1245x497mm	✓	✓	✓	✓	✓	✓
***126	1245x597mm	✓	✓	✓	✓	✓	✓

Note: • 1965 Larder Doors have a fixed handle height of 889mm. This lines through with adjacent 1245mm door configurations (70/30 F/F).
• Larder doors are handed

Fixed Right Fixed Left

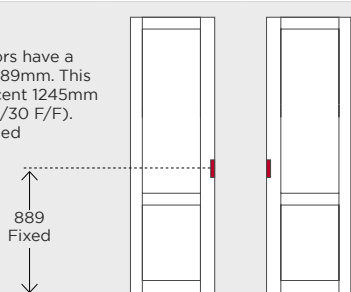

889
Fixed

Tall Larder doors

***193	1965x297mm (cross rail)	✓	✓
***196	1965x597mm (cross rail)	✓	✓

Note: • Robe doors are handed

Fixed Right Fixed Left

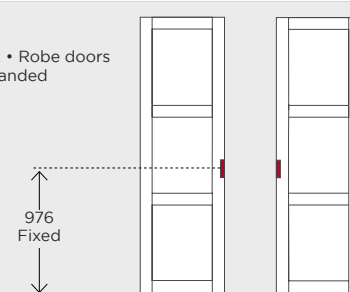

976
Fixed

Robe doors

***2154x397	2154x397mm (3 panel design, 2 cross rails)	✓	✓
***2154x447	2154x447mm (3 panel design, 2 cross rails)	✓	✓
***2154x497	2154x497mm (3 panel design, 2 cross rails)	✓	✓



MORNINGTON SHAKER & BEADED EDGE

		Top Side Right	Top Side Left	Bottom Side Right	Bottom Side Left
Corner doors					
***WCDS	715x277x20mm wall corner door solution, (pair)	-	-	✓	✓
***CDS	715x313x20mm base corner door solution, (pair)	✓	✓	-	-

Note: Corner doors come as a pair. Handle features on one door only.

		Top Central	Top Side Right	Top Side Left	Bottom Central	Bottom Side Right	Bottom Side Left
Glazed doors							
***714CG	715x397mm, clear glazed	✓	✓	✓	✓	✓	✓
***715CG	715x497mm, clear glazed	✓	✓	✓	✓	✓	✓
***895CG	895x497mm, clear glazed	✓	✓	✓	✓	✓	✓

KEY INFORMATION

Frontal Prefix Codes

Shaker

Stocked - **MGSO**
Paint-to-order - **MGXO**

Beaded

Stocked - **MBSO**
Paint-to-order - **MBXO**

X The following frontal sizes from stocked Mornington Shaker and Mornington Beaded are not available in Mornington Edge

***116 115x597mm (slab)

***715X257 715x257mm

***CD716 715x300mm, Small Curved Door



*Subject to capacity



Mornington Shaker Regents Green shown with Oak backplates

HANDLE LOCATION

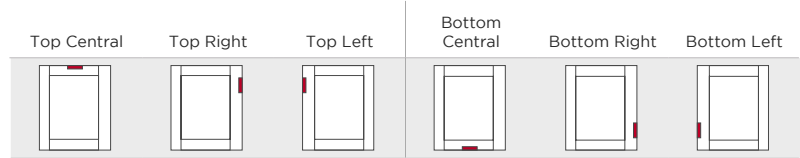

Recommended handle locations are illustrated on the doors below.

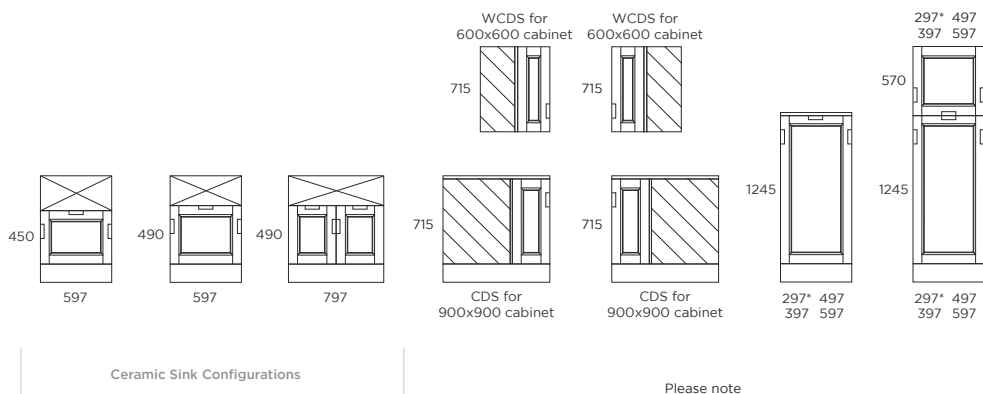
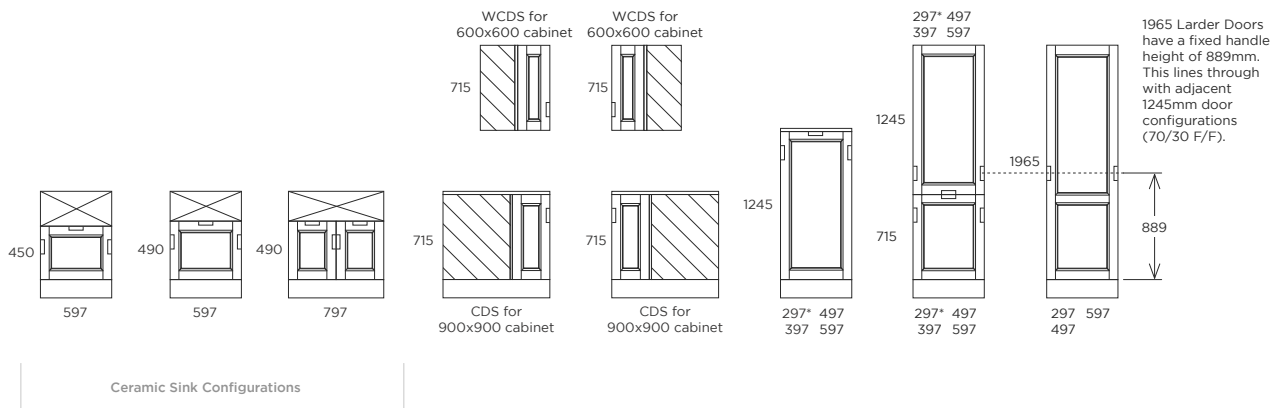
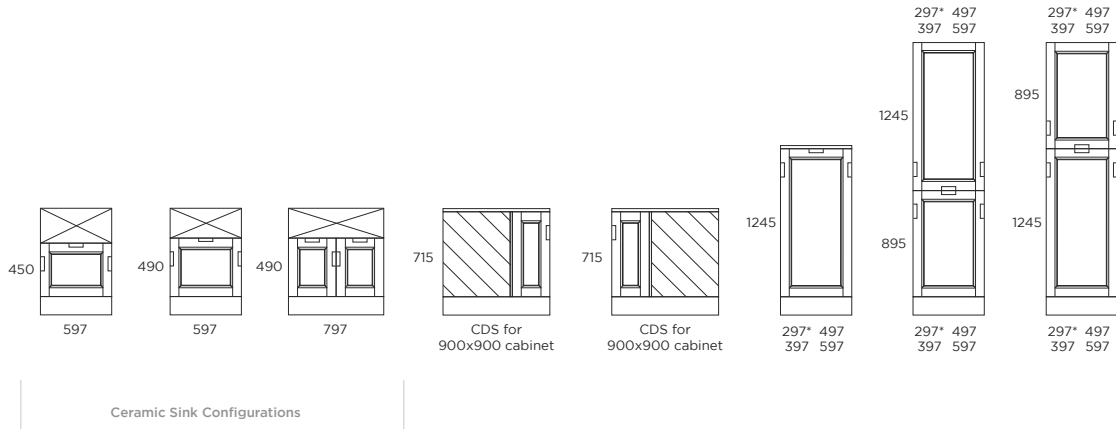

Please note
 *Not all handle locations available (please see 'Handle Location Guide' for more information)
 * W297/325 not applicable with top central handle location due to door construction.

HANDLE LOCATION

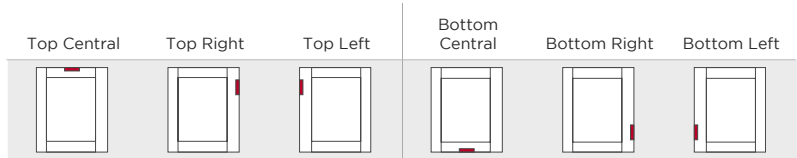

Recommended handle locations are illustrated on the doors below.

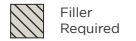

Single Oven & Microwave or Coffee Machine Configurations

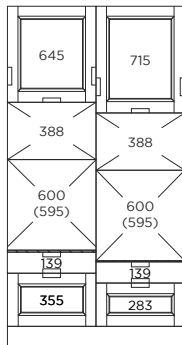

Double Oven Configurations

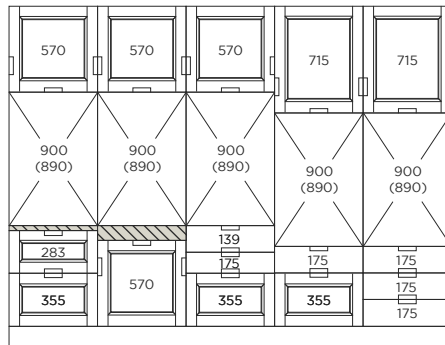

Fridge/Freezer Configurations



Please note: For Fridge/Freezer Doors it is recommended to use Right or Left handle locations.

Double Oven Configurations

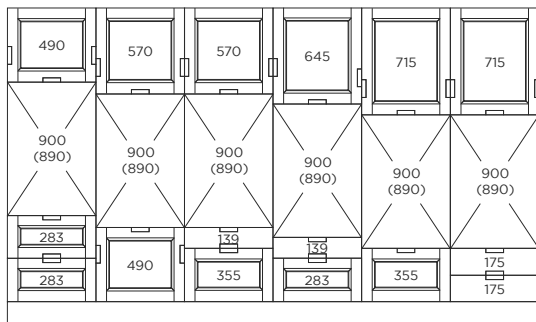

Compact & Warming Drawer Configurations

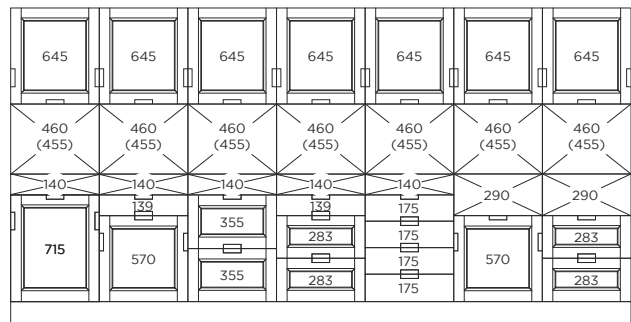

Fridge/Freezer Configurations



Please note: For Fridge/Freezer Doors it is recommended to use Right or Left handle locations.

Please note:

* Mounted handle recommended on configuration

Please note:

- Specialist appliance brands such as Miele, Sub Zero and Wolf adopt a different size matrix.
- If fillers must be used, typically a 139 x 597mm drawer front or 115 x 597mm oven trimmer are the most recommended products. Cut to size along the length to suit the void, and finish the raw edge using a PWS touch up kit.

Please note

*Not all handle locations available (please see 'Handle Location Guide' for more information)



Hunton Edge shown

PLANNING WITH



OUTLINE

THE BASICS	127
BASE UNITS	128
DRAWER PACKS	130
WALL UNITS	132
LARDER UNITS	134
INTERNAL STORAGE	140
INTEGRATED APPLIANCES	142
BEDROOM RANGE MATRIX	144
HOME OFFICE RANGE MATRIX	146



Hunton Edge Porcelain shown with Carbon backplates

PLANNING WITH OUTLINE

THE BASICS

For visual purposes only, this page shows Porter with Portal handles.

This section will talk you through the basics of planning with Outline

Outline has been designed to offer you great flexibility and unlimited planning opportunities. Our extensive handle location offering can be used to help zone base units, add focal points and indicate handing of doors. Handle locations vary range-to-range, handle-to-handle. Please reference 'Handle Location Guide' for range specific information.

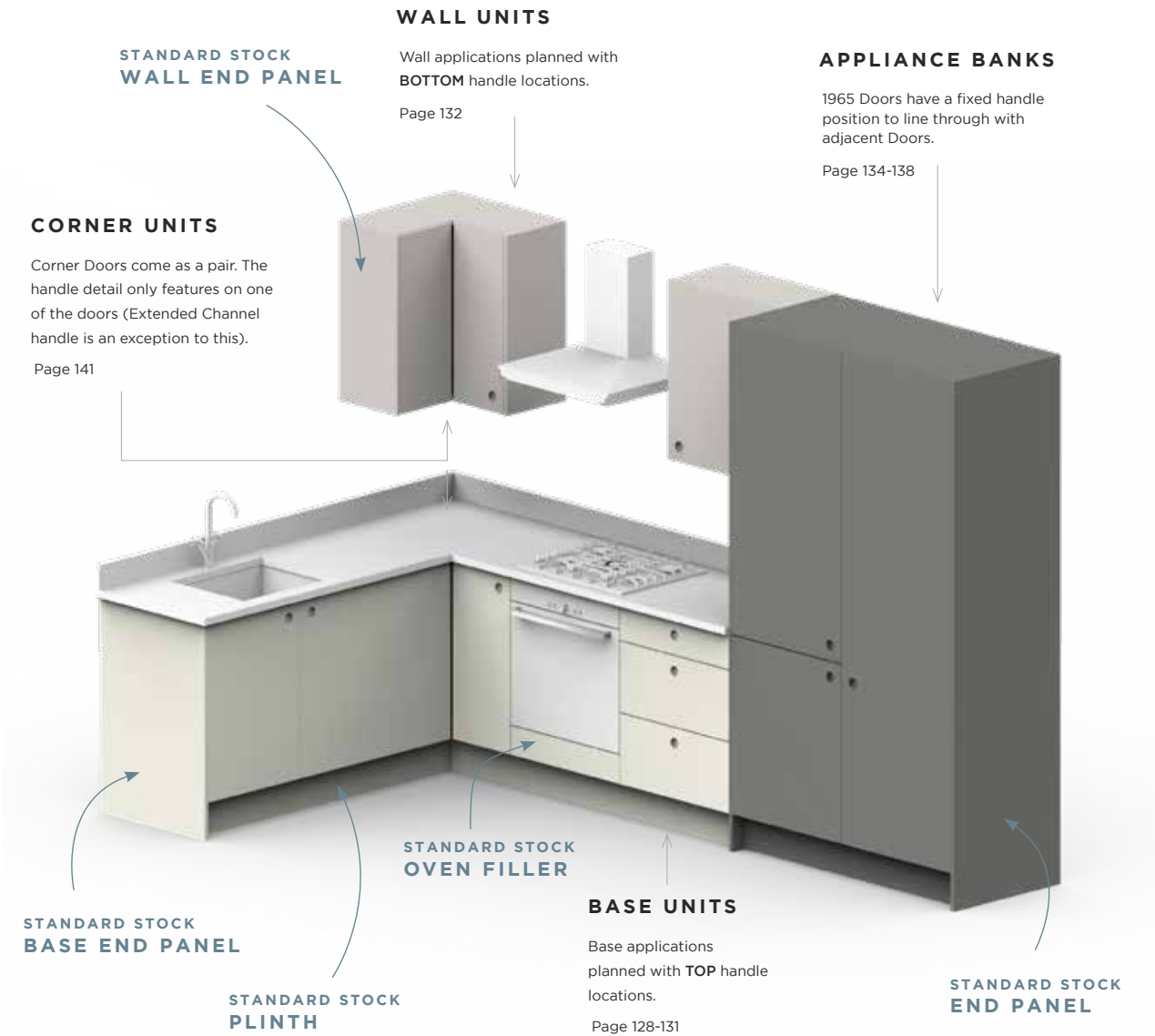

Applications where handle locations need to be carefully considered:

There are several reasons why handle locations need to be carefully considered. Including installation compatibility, range availability, opening/handling requirements and aesthetics. Please be mindful of this when planning the following applications:

INTERNAL STORAGE

Refer to page 140-141 for more details.

KESSEBÖHMER **Gollinucci**
DESIGNED FOR ENERGY CLASS

INTEGRATED APPLIANCES

Refer to page 142-143 for more details.

LARDER

1965 DOORS

Refer to page 134-138 for more details.

PLANNING WITH BASE UNITS

PLANNING STYLES

Outline has 2 main planning styles. Style 1 reflects the handing and opening of doors, whilst Style 2 is very much driven by symmetrical aesthetics. Both styles offer sophistication and really welcomes an individual to express their personality and create a tailored kitchen that meets all their needs and demands. Please reference 'Handle Location Guide' for range specific information.

STYLE 1

This planning style is all about functionality and choosing handle locations that reflect the handing/opening of the frontals. With a plethora of handle locations to suit a variety of applications, zoning areas of the kitchen is easy and works effectively in breaking up long unit runs.

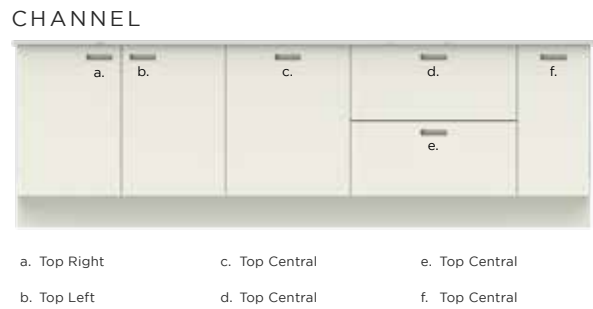
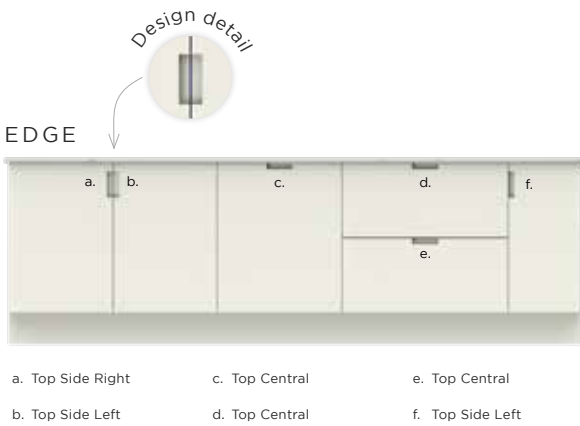
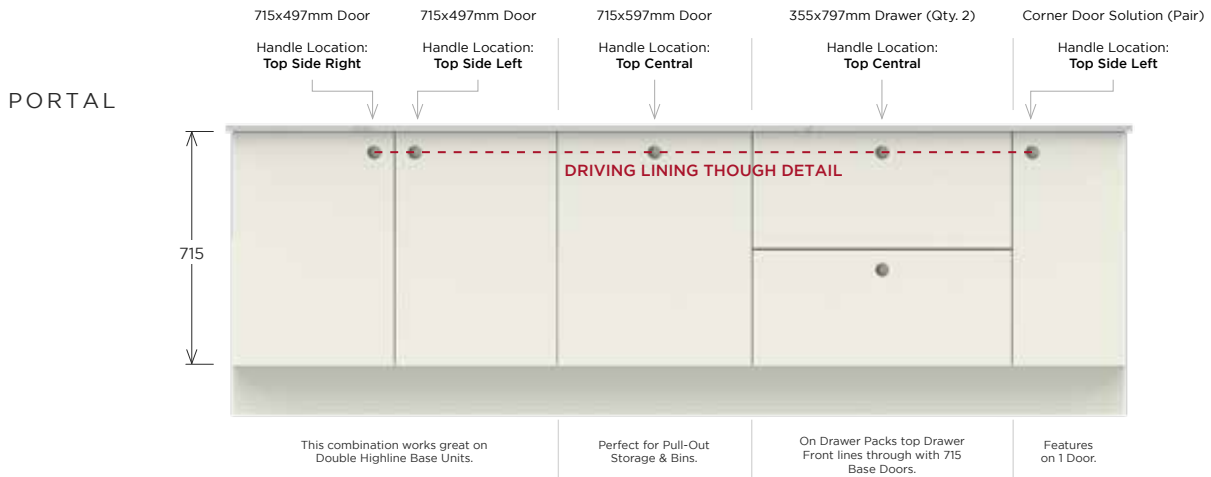

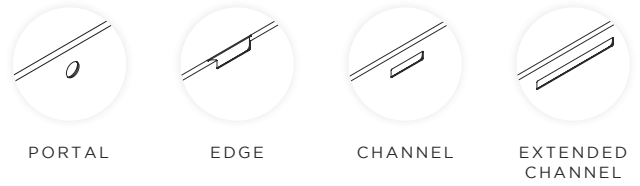

STYLE 2

Driven by the modern, linear aesthetic, this planning style is made up of either standard 715 doors or wide Pan Drawers featuring Top Central handle locations across the whole kitchen. The minimal design style offers an open and airy feel whilst welcoming rich textures and statement accent colours. Uniformity and symmetry is key.

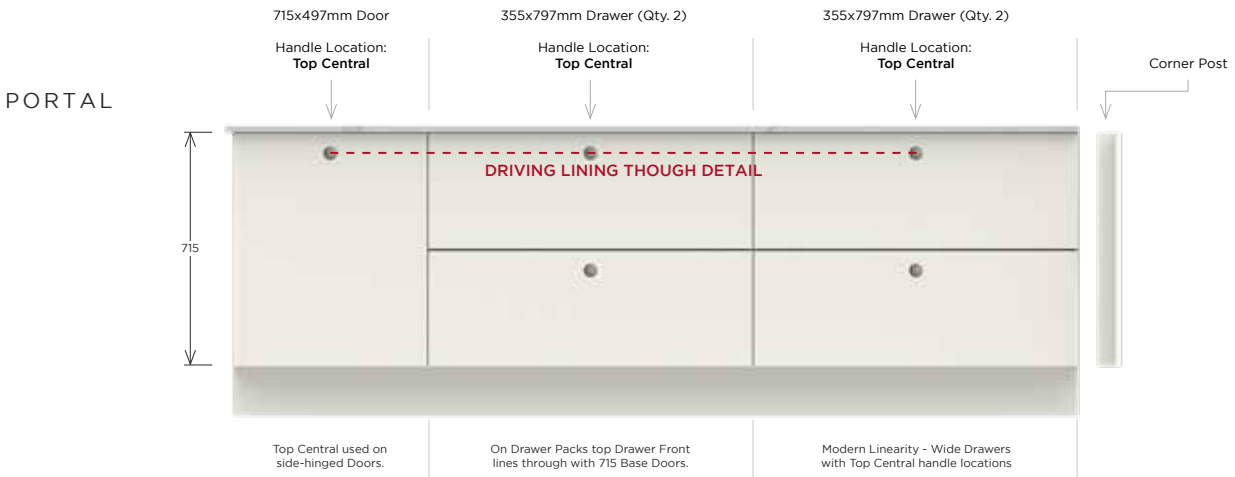

EDGE



All fascias feature a Top Central handle including Doors & Drawer Packs

CHANNEL



All fascias feature a Top Central handle including Doors & Drawer Packs

EXTENDED CHANNEL



All fascias feature a Top Central handle including Doors & Drawer Packs



Mornington Shaker Regents Green shown with Oak backplates



PLANNING WITH DRAWER PACKS CONFIGURATIONS

Did you know you can inject even more personality into your kitchen design by taking full advantage of the Top Central and Bottom Central handle locations that are available on drawer fronts. On drawer pack configurations the Edge handle can be planned like that of rail systems where you pull the drawer from the bottom.

Please note:
Only 1 x handle per drawer front. A drawer front with 2 x handles is not available.

SUGGESTED DRAWER CONFIGURATIONS

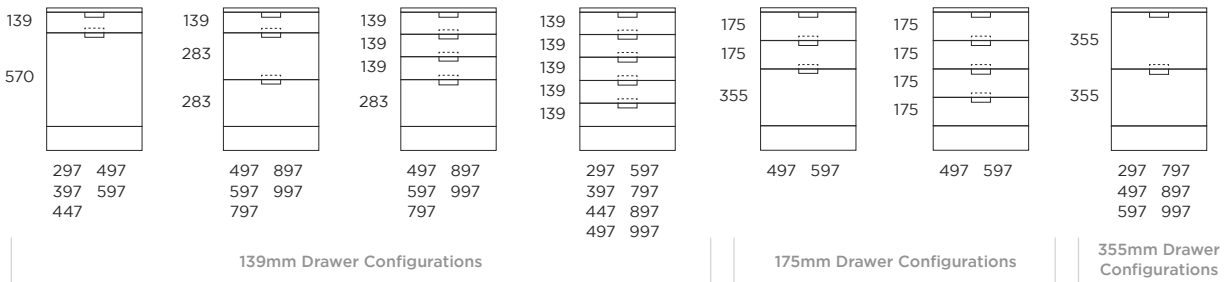

**PORTER
EDGE**

**HUNTON
EDGE**

**FITZROY
EDGE**

**MORNINGTON
BEADED & SHAKER
EDGE**

139MM DRAWER CONFIGURATIONS

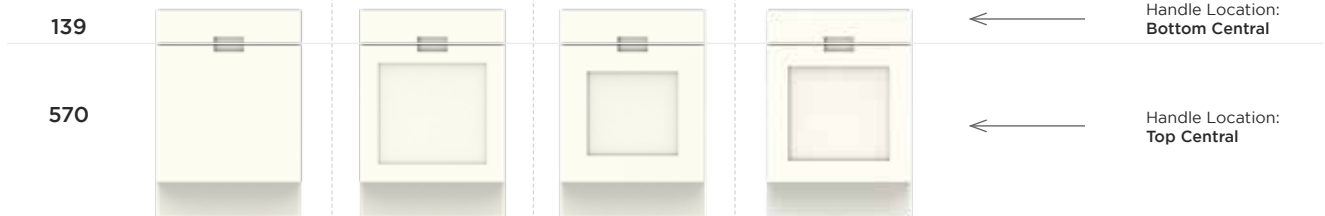

175MM DRAWER CONFIGURATIONS



355MM DRAWER CONFIGURATIONS



PLANNING WITH WALL UNITS

BOTTOM HANDLE LOCATIONS

Wall Units are planned using Bottom handle locations, with a Central, Left and Right offering. Compatible with 715mm Doors, 895mm Doors, Low Extractor Doors, Bi-Fold Doors and so-on. Handle locations vary range-to-range, handle-to-handle. Please reference 'Handle Location Guide' for range specific information.

PORTAL

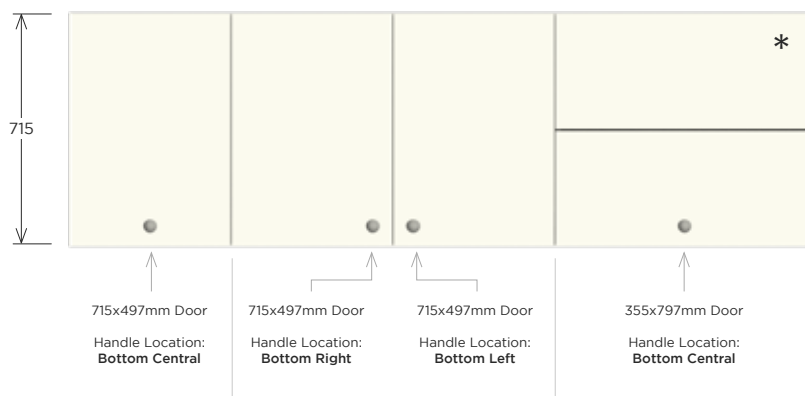

* On Bi-Fold Door configurations it is recommended not to have an Outline handle on the top Door.

EDGE

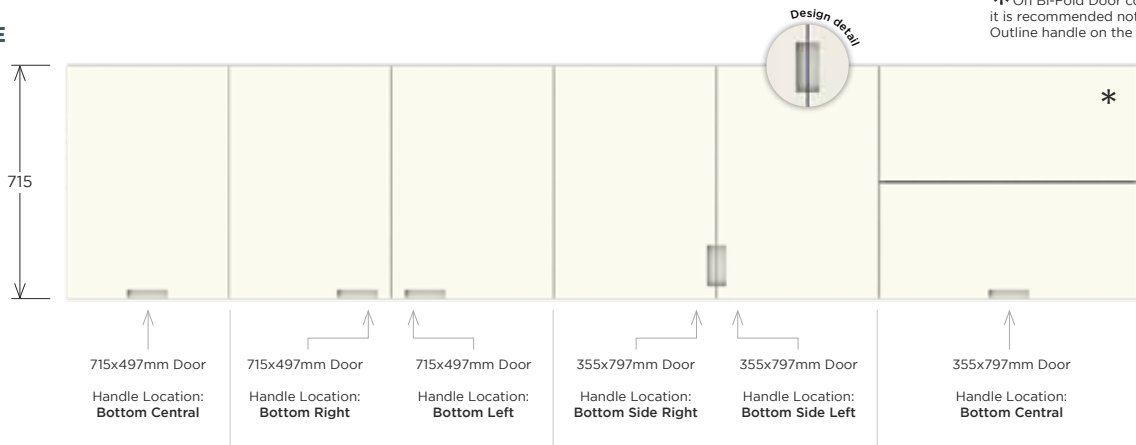

* On Bi-Fold Door configurations it is recommended not to have an Outline handle on the top Door.

For visual purpose only, this page shows Porter with Outline handles.

CHANNEL

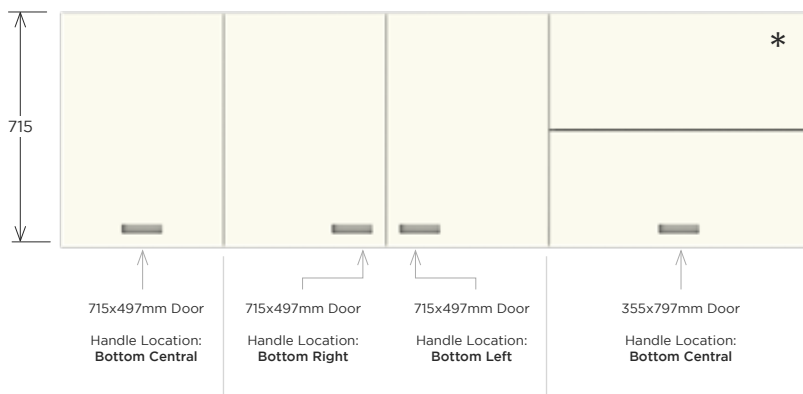

* On Bi-Fold Door configurations it is recommended not to have an Outline handle on the top Door.

EXTENDED CHANNEL

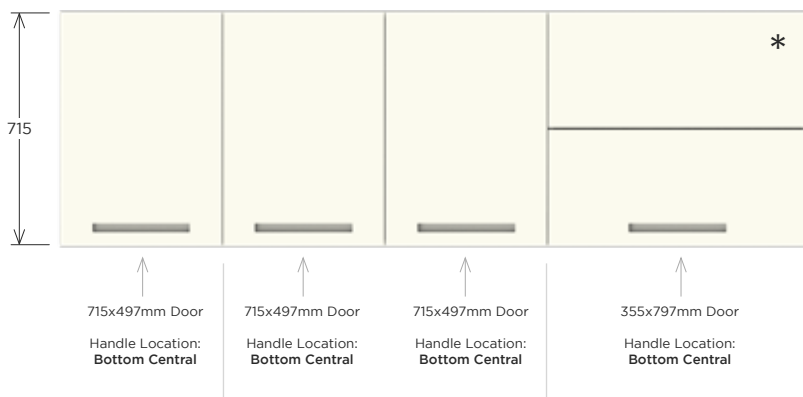

* On Bi-Fold Door configurations it is recommended not to have an Outline handle on the top Door.

PLANNING WITH LARDER UNITS

FIXED HANDLE HEIGHT

An important area to understand when it comes to planning and designing with Outline, is the fixed handle height that features on 1965 Larder Doors. The fixed handle height varies range-to-range and handle-to-handle. Meeting ergonomic demands, the fixed handle height also lines through with adjacent doors as illustrated on the following pages.

PORTER PORTAL

Please note: Range specific, fixed position differs from Fitzroy Portal.

WHAT DOES IT LINE THROUGH WITH?

A Porter Portal 1965 Larder Door has a fixed handle height of 654mm. This lines through with adjacent 715mm base unit configurations.

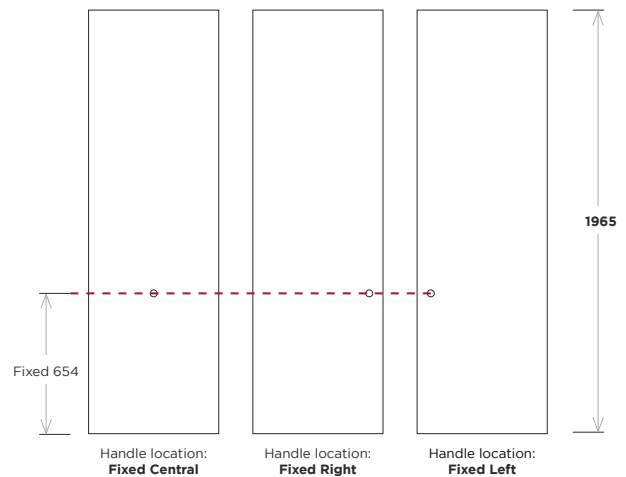
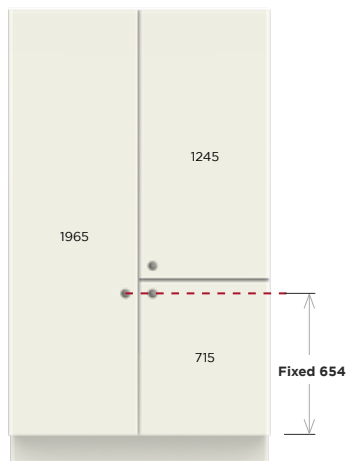

PORTER EDGE

Please note: Range specific, fixed position differs from Fitzroy Edge, Hunton Edge, Mornington Beaded & Shaker Edge.

WHAT DOES IT LINE THROUGH WITH?

A Porter Edge 1965 Larder Door has a fixed handle height of 819mm. This lines through with adjacent 70/30 Fridge/Freezer configurations.

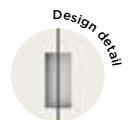
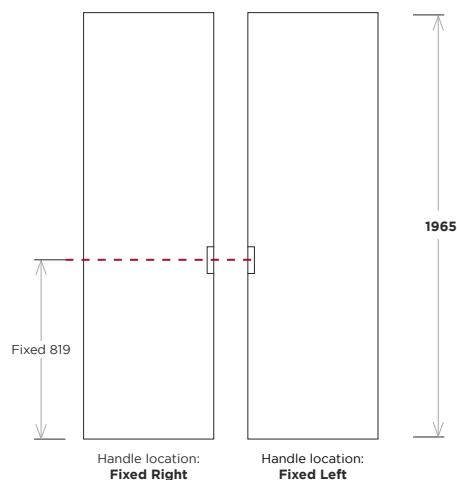
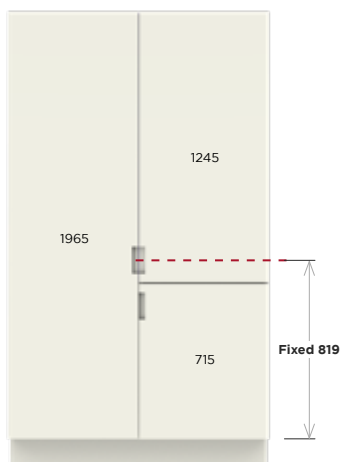

PORTER CHANNEL

Please note: Channel is only available in Porter door range.

WHAT DOES IT LINE THROUGH WITH?

A Porter Channel 1965 Larder Door has a fixed handle height of 661mm. This lines through with adjacent 715mm base unit configurations.

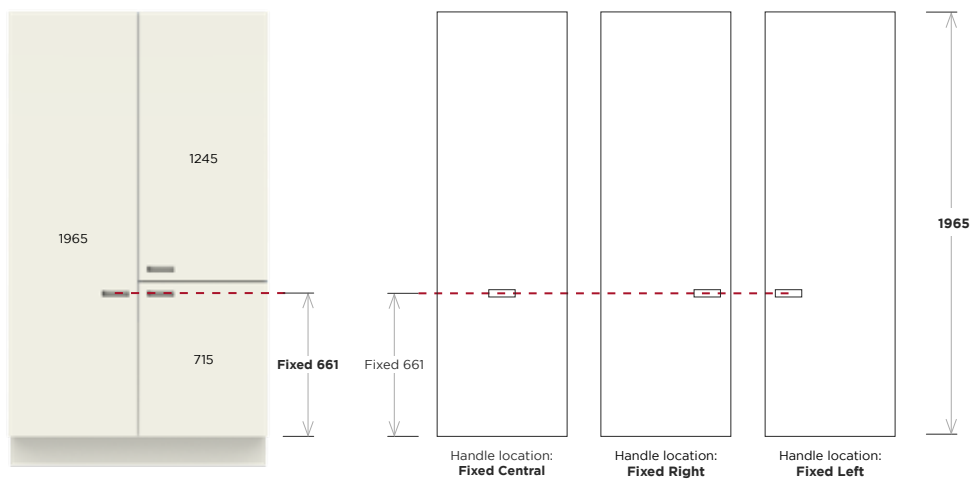

PORTER EXTENDED CHANNEL

Please note: Extended Channel is only available in Porter door range.

WHAT DOES IT LINE THROUGH WITH?

A Porter Extended Channel 1965 Larder Door has a fixed handle height of 661mm. This lines through with adjacent base unit configurations.

Vertical handle positions line through with the bottom edge of fixed central handle.

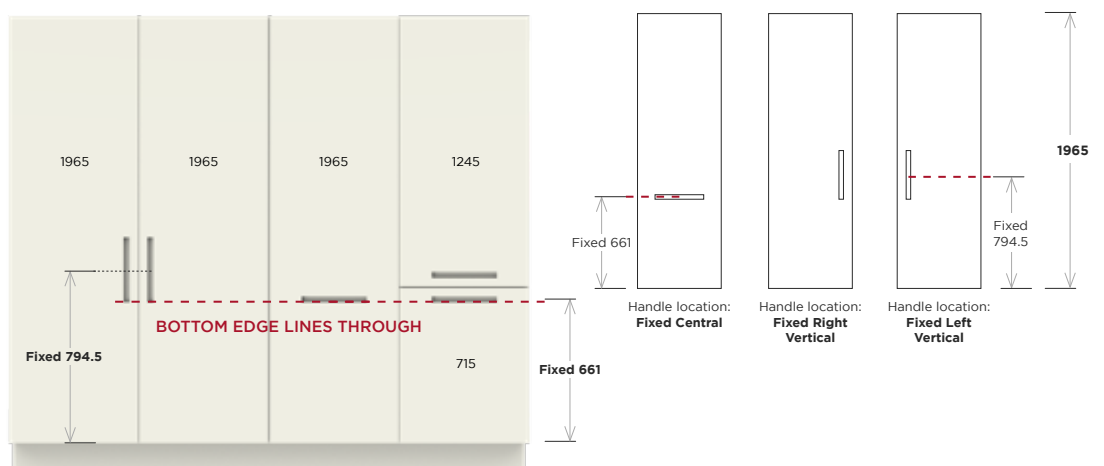



PLANNING WITH LARDER UNITS

FIXED HANDLE HEIGHT

An important area to understand when it comes to planning and designing with Outline, is the fixed handle height that features on 1965 Larder Doors. The fixed handle height varies range-to-range and handle-to-handle. Meeting ergonomic demands, the fixed handle height also lines through with adjacent doors as illustrated on the following pages.

FITZROY PORTAL

Please note: Range specific, fixed position differs from Porter Portal.

WHAT DOES IT LINE THROUGH WITH?

A Fitzroy Portal 1965 Larder Door has a fixed handle height of 662mm. This lines through with adjacent 715mm base unit configurations.

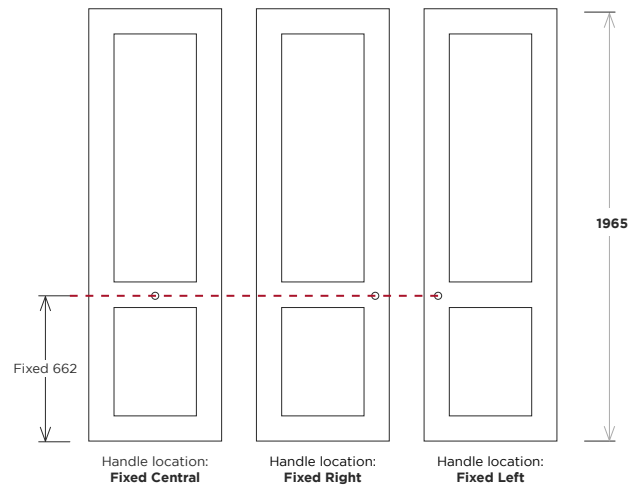
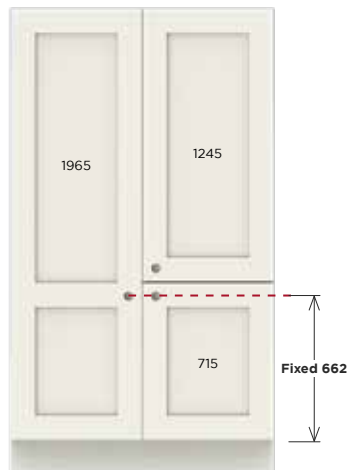

FITZROY EDGE

Please note: Range specific, fixed position differs from Porter Edge.

WHAT DOES IT LINE THROUGH WITH?

A Fitzroy Edge 1965 Larder Door has a fixed handle height of 889mm. This lines through with adjacent 70/30 Fridge/Freezer configurations.

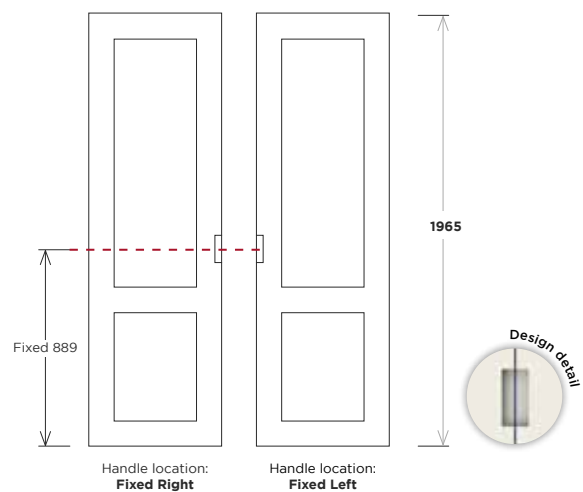
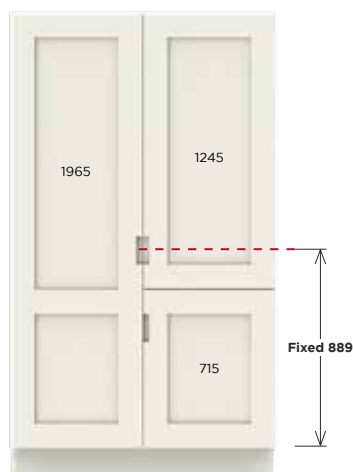

HUNTON EDGE

Please note: Range specific, fixed position differs from Porter Edge.

WHAT DOES IT LINE THROUGH WITH?

A Hunton Edge 1965 Larder Door has a fixed handle height of 889mm. This lines through with adjacent 70/30 Fridge/Freezer configurations.

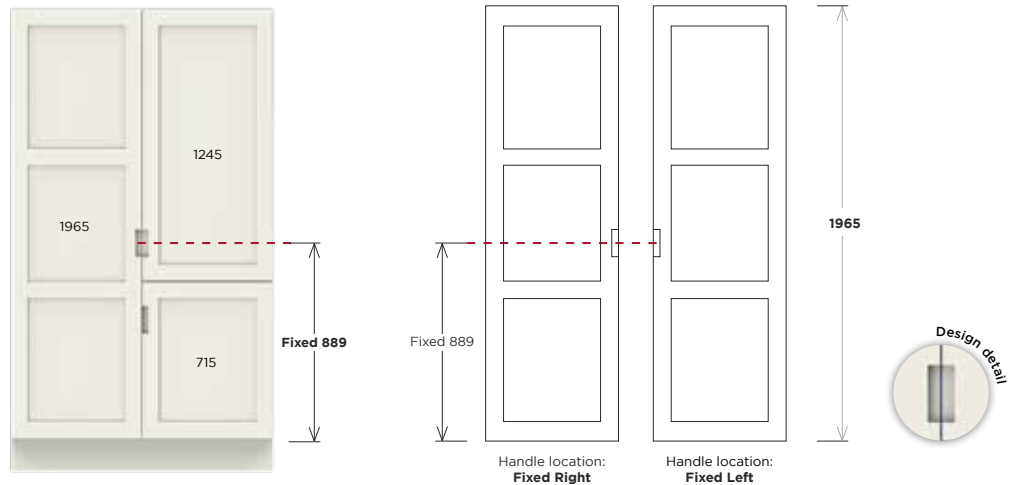

PLANNING WITH LARDER UNITS

FIXED HANDLE HEIGHT

An important area to understand when it comes to planning and designing with Outline, is the fixed handle height that features on 1965 Larder Doors. The fixed handle height varies range-to-range and handle-to-handle. Meeting ergonomic demands, the fixed handle height also lines through with adjacent doors as illustrated on the following pages.

MORNINGTON BEADED EDGE

Please note: Range specific, fixed position differs from Porter Edge.

WHAT DOES IT LINE THROUGH WITH?

A Mornington Beaded Edge 1965 Larder Door has a fixed handle height of 889mm. This lines through with adjacent 70/30 Fridge/Freezer configurations.

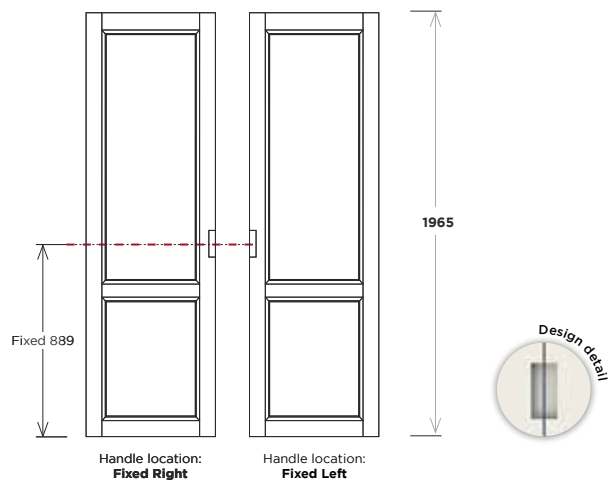

MORNINGTON SHAKER EDGE

Please note: Range specific, fixed position differs from Porter Edge.

WHAT DOES IT LINE THROUGH WITH?

A Mornington Shaker Edge 1965 Larder Door has a fixed handle height of 889mm. This lines through with adjacent 70/30 Fridge/Freezer configurations.

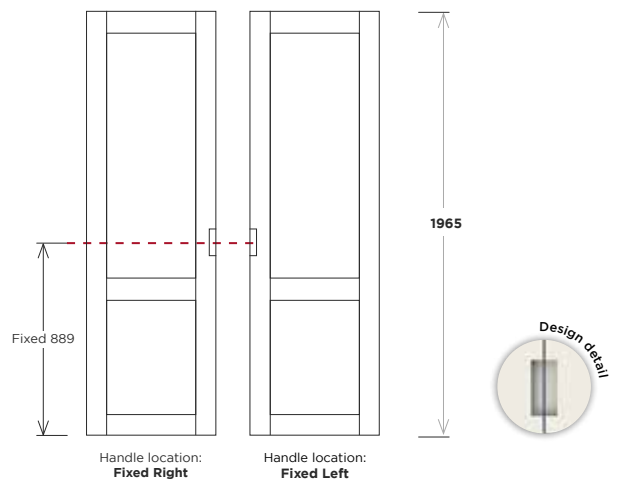



Mornington Shaker Porcelain shown with Matching backplates

PLANNING WITH INTERNAL STORAGE

Internal storage including Kesseböhmer and Gollinucci can be planned with the Outline product offering. Upon installation, please be mindful of the backplate to the back of the door. Do not drill through the backplates for fixing of the internal storage. Simply adjust fixing points accordingly to avoid any collisions.

Please note
Fixing points may need to be adjusted accordingly to avoid collision with the backplate.

BASE UNIT STORAGE



PULL-OUT TOWEL RACK

Use: Transforms narrow spaces, great for use on either side of your sink or oven.

Cabinet widths: 150mm*

Tray styles: Silver Classic, Chrome Classic, Anthracite Style, Chrome Style

*Channel and Extended Channel handle not compatible

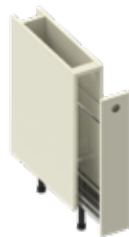

PULL-OUT TRAY RACK

Use: Transforms narrow spaces, great for use on either side of your sink or oven.

Cabinet widths: 150mm*

Tray styles: Silver Classic, Chrome Classic, Anthracite Style, Chrome Style

*Channel and Extended Channel handle not compatible



BASE UNIT PULL-OUT

Use: Tested to 60,000 cycles, the entire contents come out in a single movement.

Cabinet widths: 150*, 300*, 400, 500, 600mm

Tray styles: Silver Classic, Chrome Classic, Anthracite Style, Chrome Style

*Channel and Extended Channel handle not compatible

LARDER UNIT STORAGE



PULL-OUT LARDER

Movement: Tested to 60,000 cycles, the entire contents comes all the way out in a single movement.

Cabinet widths: 300, 400, 500mm

Tray styles: Silver Classic, Chrome Classic, Chrome Arena, Anthracite Style, Chrome Style



SWING LARDER

Movement: Can be turned left or right (90 degrees) for easy access to either side.

Cabinet widths: 300mm

Tray styles: Chrome Arena, Chrome Style



TANDEM LARDER

Movement: The rear trays are automatically drawn forward when the front door is opened.

Cabinet widths: 500, 600mm - studio & full height

Tray styles: Silver Classic, Chrome Classic, Chrome Arena, Anthracite Style, Chrome Style



CONVOY PREMIO

Movement: Open the door and the entire contents come all the way out in a single movement.

Cabinet widths: 600mm

Tray styles: Grey (no-shatter) glass-sided anti-slip trays



FITTING INSTRUCTIONS

Kesseböhmer and Gollinucci products come with fitting instructions and drilling templates for a quick and simple installation.

QR codes can be found printed on the box of Kesseböhmer products. This takes you directly to the fitting instructions homepage where you will find fitting videos and technical data sheets.

Comprehensive installation videos can also be found on YouTube by searching 'PWS Distributors'.

CORNER UNIT STORAGE



MAGIC CORNER

Movement: Attached to the back of the door, both trays slide simultaneously for full access.

Cabinet widths: 900, 1000mm

Tray styles: Silver Classic, Chrome Classic, Chrome Arena, Chrome Style



LEMANS II

Movement: Each tray swings out of the cabinet completely and independently

Cabinet widths: 764, 800, 910, 960mm

Tray styles: Silver Arena, Chrome Arena, Anthracite Style, Chrome Style



CORNER CAROUSEL

Movement: Centre mounted for 360 degree access.

Cabinet widths: 900x900mm

Tray styles: Chrome Arena, Chrome Style, Silver Classic, Chrome Classic

Note: Extended Channel handle not compatible

RECOMMENDED HANDLE LOCATIONS

Whilst Outline offers a vast array of handle locations for multiple applications, the below table illustrates our recommendations when planning Kesseböhmer internal storage. Please reference "Outline handle locations" pages, that are range specific.

	PORTAL	EDGE	CHANNEL	EXTENDED CHANNEL
Base Unit Storage				
150 Pull-Out	Top Central	Top Side Left / Top Side Right	n/a	n/a
Base Unit Pull-Out	Top Central	Top Central *	Top Central *	Top Central *
Larder Unit Storage				
Pull-Out Larder	Fixed Central	Fixed Left / Fixed Right	Fixed Central	Fixed Central * Fixed Vertical Left / Fixed Vertical Right
Swing Larder	Fixed Central	Fixed Left / Fixed Right	Fixed Central	Fixed Vertical Left / Fixed Vertical Right
Tandem Larder	Fixed Left / Fixed Right	Fixed Left / Fixed Right	Fixed Left / Left Right	Fixed Vertical Left / Fixed Vertical Right
Convoy Premio	Fixed Left / Fixed Right	Fixed Left / Fixed Right	Fixed Left / Left Right	Fixed Vertical Left / Fixed Vertical Right
Corner Unit Storage				
Magic Corner	Top Central	Top Central	Top Central	Top Central
LeMans II	Top Left / Top Right	Top Side Left / Top Side Right	Top Left / Top Right	Top Central
Corner Carousel	Top Left / Top Right	Top Side Left / Top Side Right	Top Left / Top Right	n/a

* Not compatible with certain sizes - this could be for a number of reasons including width of door being too small to accommodate handle or door construction limiting handle location offering.



Did you know?
For greater grip on doors with heavy internal storage you can use a mounted handle. See page 193 for our handle recommendations.

PLANNING WITH INTEGRATED APPLIANCES

RECOMMENDED HANDLE LOCATIONS

The planning of integrated appliances maintains a consistent look throughout a kitchen. Outline can be used for integrated appliances with the added option of using a standard handle for increased grip. The information below lists recommended handle locations to use when it comes to planning with integrated appliances. Handle location is key in this instance to reflect the opening and maintain the functionality of Washer/Dryers, Fridge Freezers and Dishwashers.



DID YOU KNOW?

For greater grip on doors with heavy internal storage you can use a standard handle. See page 192-201 for our handle recommendations.

Please note
Fixing points may need to be adjusted accordingly to avoid collision with the backplate.

INTEGRATED WASHER/DRYER

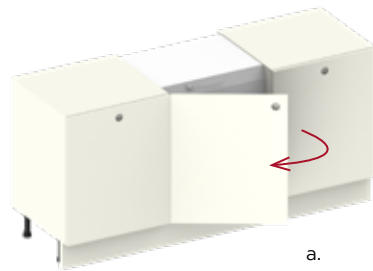

a.

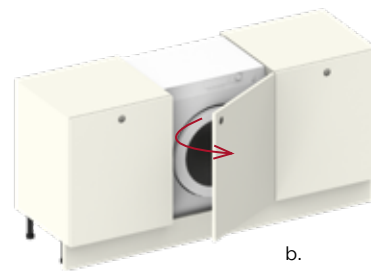

b.

	a. Left Handed Appliances	b. Right Handed Appliances
PORTAL	Top Right	Top Left
EDGE	Top Side Right	Top Side Left
CHANNEL	Top Right	Top Left
EXTENDED CHANNEL	Top Central	Top Central

INTEGRATED DISHWASHER

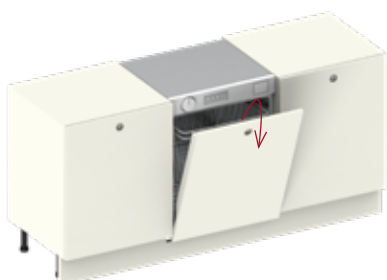

	Swing Open Appliances
PORTAL	Top Central
EDGE	Top Central
CHANNEL	Top Central
EXTENDED CHANNEL	Top Central

INTEGRATED UNDERMOUNT FRIDGE/FREEZER

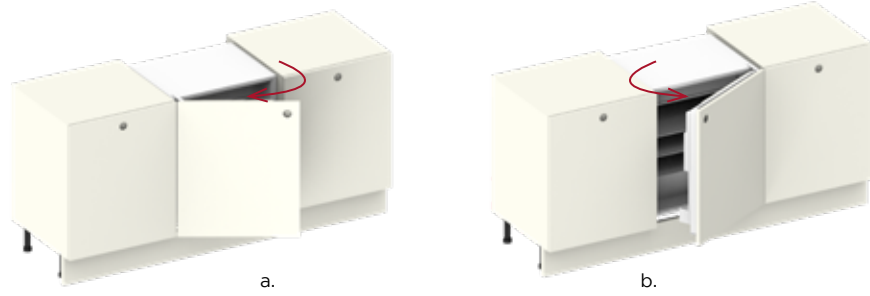

	a. Left Handed Appliances	b. Right Handed Appliances
PORTAL	Top Right	Top Left
EDGE	Top Side Right	Top Side Left
CHANNEL	Top Right	Top Left
EXTENDED CHANNEL	Top Central	Top Central

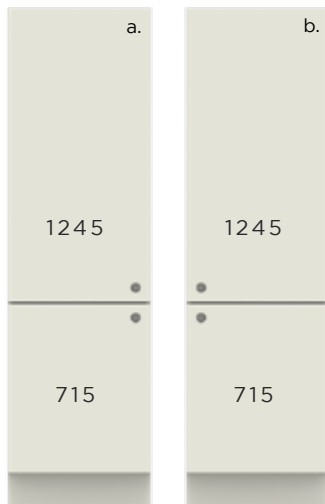

INTEGRATED 70/30 FRIDGE/FREEZER

	Doors	a. Left Handed Appliances	b. Right Handed Appliances
PORTAL	1245 Door	Bottom Right	Bottom Left
	715 Door	Top Right	Top Left
EDGE	1245 Door	Bottom Side Right	Bottom Side Left
	715 Door	Top Side Right	Top Side Left
CHANNEL	1245 Door	Bottom Right	Bottom Left
	715 Door	Top Right	Top Left
EXTENDED CHANNEL	1245 Door	Bottom Central	Bottom Central
	715 Door	Top Central	Top Central

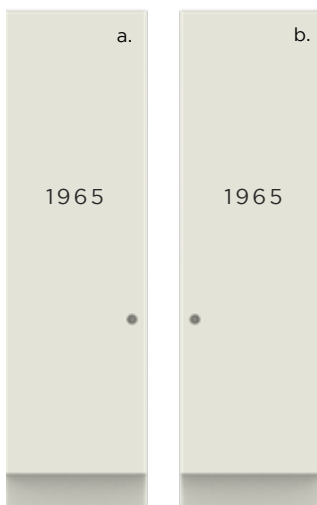

INTEGRATED FULL HEIGHT FRIDGE/FREEZER

	a. Left Handed Appliances	b. Right Handed Appliances
PORTAL	Fixed Right	Fixed Left
EDGE	Fixed Right	Fixed Left
CHANNEL	Fixed Right	Fixed Left
EXTENDED CHANNEL	Fixed Right Vertical	Fixed Left Vertical

Whilst you can open an integrated full height Fridge Freezer with an Outline handle, it is recommended to use a standard handle due to the weight behind the door.

BEDROOM RANGE MATRIX FOR CLASSIC & MODERN DOOR FAMILIES

Our selection of Bedroom Frontals & Accessories enables a wide range of storage solutions including wardrobes, storage chests, bedside tables and dressing tables across Classic & Modern designs. The below highlights some key details to be mindful of when it comes to planning with our Bedroom components, including door drilling, suggested storage chest configurations and dressing table requirements.

Frontals, accessories, handles, drawer box and runners are available from stock.

215 SPECIFIC MATRIX

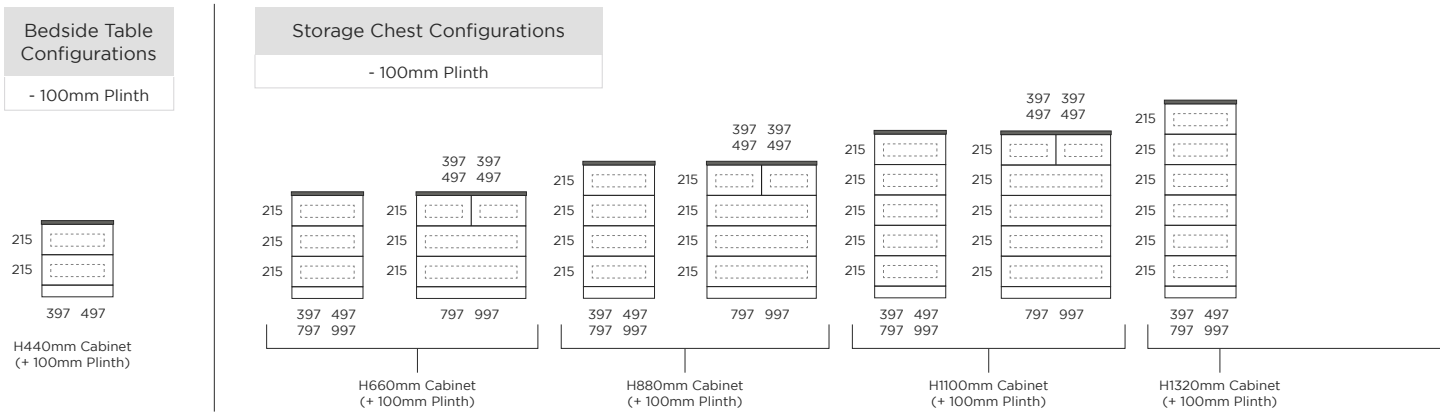

ADDITIONAL CONFIGURATIONS

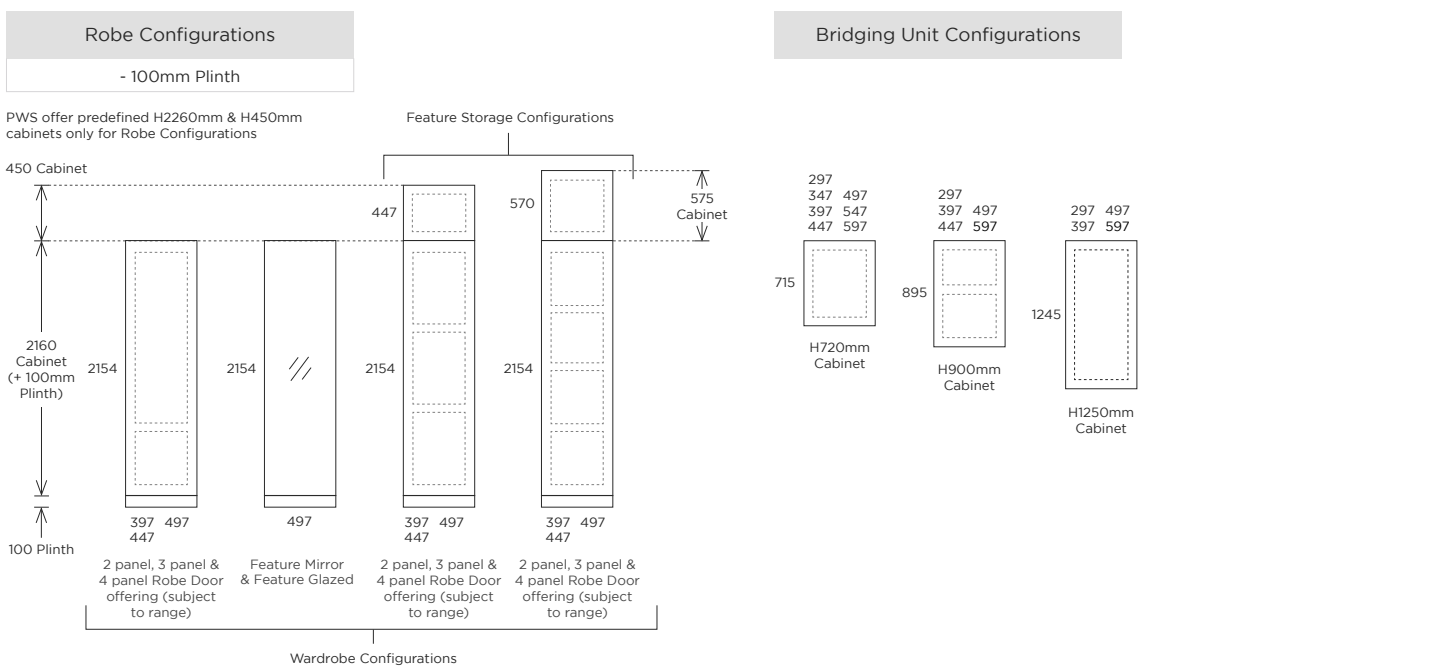
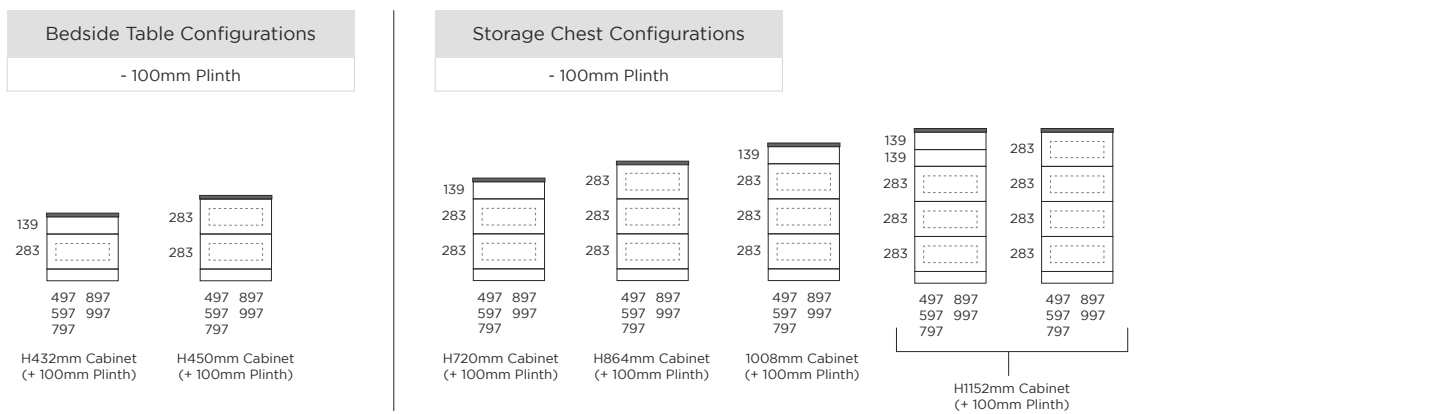

Bedroom Ranges that can adopt the below matrix include: Belsay, Hunton, Mornington Beaded, Porter, Sculpt*, Stanhope & Unity.

Please note: Chapter and Feature Mirror Doors come pre-drilled only to suit PWS Bedroom Cabinets. These ranges offer wardrobe planning only, including H447 feature storage doors.

*wardrobes only



PLINTH HEIGHTS

We have a selection of Bedroom Plinths to help achieve all the configurations shown on this page. Please note: Dressing Table configurations require a 150mm Plinth for ergonomic reasons, which offers an optimum table height of 725mm.

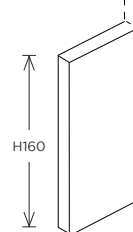

Custom Fit Plinth/Infil Panel (**CTP160)
- For use when scribing to an uneven floor

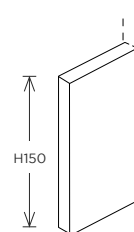

Plinth (**P30)
- For use when planning Dressing Table Configurations

Only in selected ranges

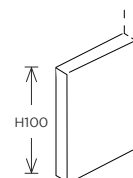

Bedroom Plinth (**BP100)
- For use when planning Bedside Table, Storage Chest & Robe Configurations

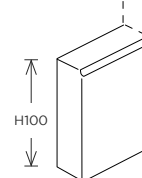

Bedroom Moulded Plinth (**MP100)
For use when planning Bedside Table, Storage Chest & Robe Configurations

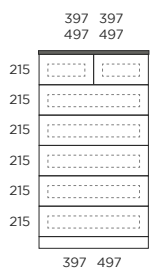

Dressing Table Configurations

- 100mm Plinth

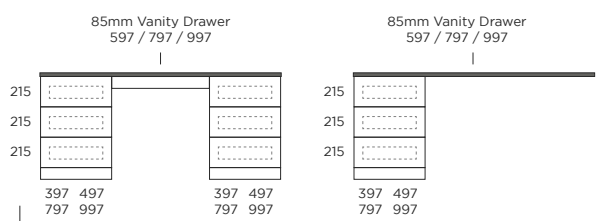

H660mm Cabinet (+ 100mm Plinth) either side of Vanity Drawer

Dressing Table Configurations

150mm Plinth

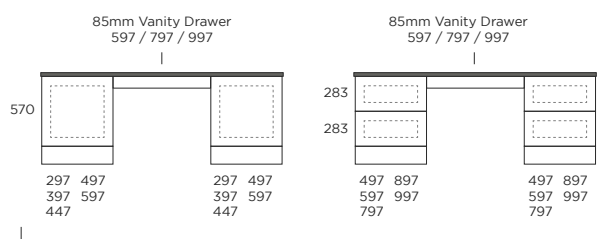

H575mm Cabinet (+ 150mm Plinth) either side of Vanity Drawer



STOCKED CABINETS

PWS stocked Bedroom cabinets are available in the following sizes:

- H2260 x D400/450/500/800/900/1000 - to suit bedroom door size H2154 x W397/447/497
- H450 x D400/450/500/1000 - to suit feature door size H447 x W397/447/500

DOOR DRILLING SERVICE

All doors are supplied undrilled except Chapter and Feature Mirror/Glazed*. Robe Doors have 2 applicable drilling patterns - 1. To suit PWS Bedroom Wardrobe Cabinet and 2. Standard PWS Drilling 100mm Top/Bottom. Standard PWS Drilling 100mm Top/Bottom applies to all other doors. Please state drilling preference at time of order.

*Chapter and Feature Glazed/Mirror 2154mm door are predrilled to suit the PWS Bedroom Wardrobe Cabinet

BEDSIDE, CHEST & DRESSING TABLE TOPS

Please reference the Worksurface section in the Directory to see our offering of Quartz, Granite and Timber worktops.

Alternatively, stocked or Unity Made-to-measure end panels can be used as a worktop. Painted end panels are not recommended.

HOME OFFICE RANGE MATRIX FOR CLASSIC & MODERN DOOR FAMILIES

Our selection of Home Office Frontals & Accessories enables a wide range of storage solutions including desks and wall storage across Classic & Modern designs. The below highlights some key details to be mindful of when it comes to planning with our Home Office components, including door drilling, suggested storage chest configurations and dressing table requirements.

Frontals, accessories, handles, drawer boxes and runners are available from stock.

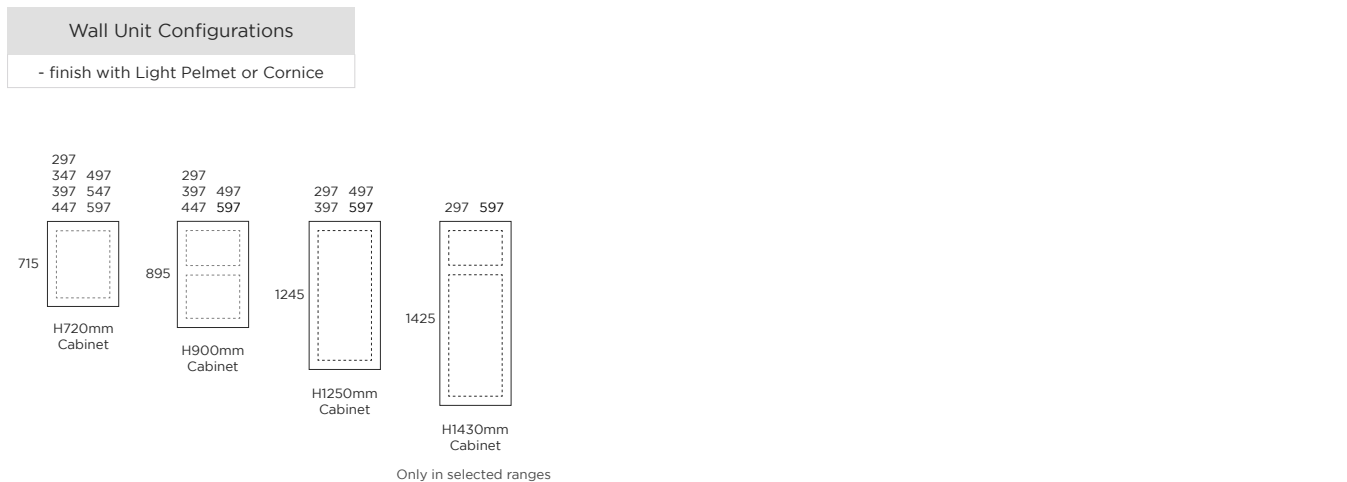
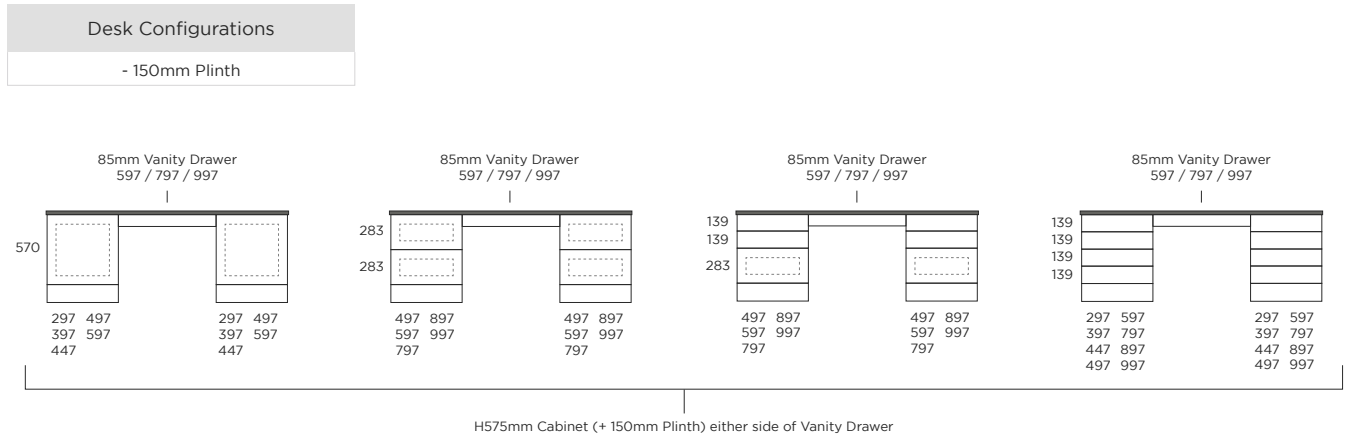

Home Office Ranges that can adopt the below matrix include: Belsay, Crathorne, Hunton, Mornington Beaded, Mornington Shaker & Porter.



RECOMMENDED CABINET DEPTHS

We recommend 3 depths of cabinets to plan with as follows:

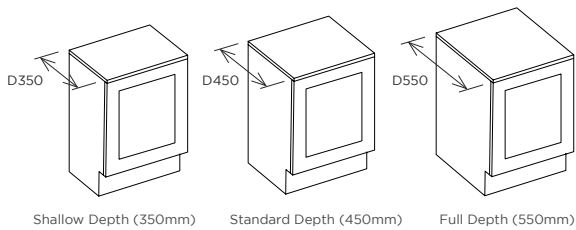

To support this we have introduced several new products including a new Legrabox drawer and new panel sizes for planning with reduced depth cabinets.

PLINTH HEIGHTS

We have a selection of Home Office Plinths to help achieve all the configurations shown on this page. Please note: Desk configurations require a 150mm Plinth for ergonomic reasons, which offers an optimum table height of 725mm.

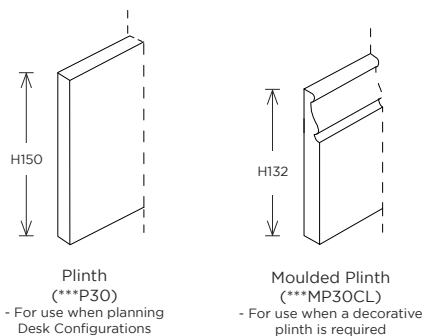

DEDICATED ACCESSORIES

***SP2400/340 | Shelving Panel, 2400x340x18mm - Aids planning and installation of open shelving features and offers better panel utilisation.

***EP2400/470 | End Panel, 2400x470x18mm - Supports Shallow Depth planning.

DESK TOPS

Please reference the Worksurface section in the Directory to see our offering of Quartz, Granite and Timber worktops.

Stocked End Panels can also be used as a worktop. Painted End Panels are not recommended.

We can also offer complementary end panels to be used as worktops through the Unity range.

DRAWER BOX OFFERING

Refer to Section 7 for LEGRABOX and Dovetail drawer box availability.





Portal shown with Matching backplate

REPLICATE THE LOOK

KITCHENS

PORTER PORTAL	150
MORNINGTON SHAKER EDGE	156
HUNTON EDGE	162
PORTER CHANNEL AND EXTENDED CHANNEL	168

BEDROOMS

PORTER PORTAL	176
MORNINGTON BEADED EDGE	180

HOME OFFICE

PORTER EXTENDED CHANNEL	184
HUNTON EDGE	188

PORTER PORTAL





REPLICATE THE LOOK

Door style: Porter

Colour: Bay Green, Dust Grey and Sage

Handle style: Portal

Backplate: Brushed Brass and Walnut

Worksurface: Strata Quartz Trinity Concrete

PORTER PORTAL

Porter Portal in Bay Green & Dust Grey with Brushed Brass backplates



BELFAST SINK

450mm door featuring a top central handle under a Belfast sink.

Pair of 715mm doors with top right handle and top left handles that give a mirrored, symmetrical appearance.

BESPOKE DOG BED

Creating using a 139mm drawer front with a top central handle and an open unit below.





OVEN HOUSING

Integrated single and compact oven configuration with 450mm appliance door top and bottom that have top central and bottom central handles.

LARDER

1965mm Larder door with a fix central handle that contains pull-out internal storage.

FRIDGE FREEZER

Integrated Fridge Freezer with a 1245mm door with bottom left handle and 715mm door with top left handle below.



PORTER PORTAL

Porter Portal in Dust Grey with Walnut backplates



BESPOKE MEDIA UNIT

Utilising contrasting woodgrain MFC panels, mixed with 490mm and 355 drawer fronts, all featuring top central handles.

Porter Portal in Sage with Walnut backplates



BESPOKE HOME OFFICE STATION

Using end panels, feature posts, 2 x 895mm doors featuring paired handles - one bottom left, one bottom right - and a 139mm drawer with a top central handle.

3 drawer pack including 139mm top drawer and 2 x 283mm drawer fronts - all with top central handles.



Porter Portal in Bay Green & with Brushed Brass backplates

MORNINGTON SHAKER EDGE

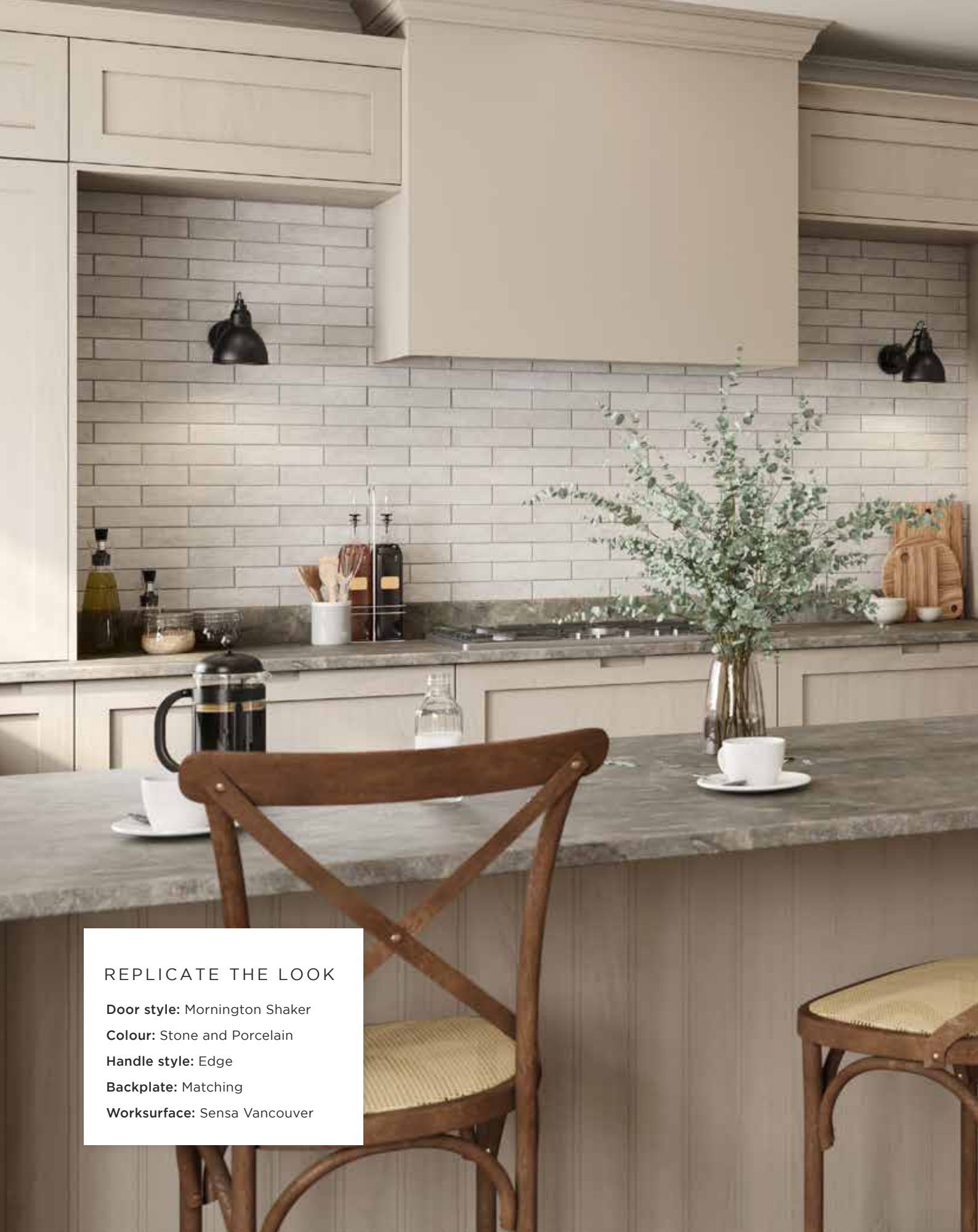

REPLICATE THE LOOK

Door style: Mornington Shaker

Colour: Stone and Porcelain

Handle style: Edge

Backplate: Matching

Worksurface: Sensa Vancouver



MORNINGTON SHAKER EDGE

Mornington Shaker Edge shown in Stone with Matching backplates



CREATE A UNIFIED LOOK

Consistent use of top central handles on base units gives a unified look.

FEATURE DOWNSTAND

Feature downstand sink matching the worktop for a modern take on the Belfast sink. A 355mm drawer featuring a top central handle sits underneath.

CORNER SOLUTIONS

Base doors with top central handles conceal a Kesseböhmer LeMans.





PUSH TO OPEN DOORS

Mixing in standard Mornington Shaker doors with no handle, with push to open mechanisms, helps to keep clean lines.

DRESSER DOORS

2 x 1245mm Dresser doors featuring paired bottom side right and bottom side left handle combination.

MIRROR HANDLE POSITION TO CREATE DESIGNER LOOK

715mm featuring paired top side right and top side left handle combination to complement the dresser doors above.

Mornington Shaker Edge in Porcelain with Matching backplates

BESPOKE WINE RACK

Edged in Frame Profile using woodgrain MFC to create the wine racks.

OVEN HOUSING

Integrated compact and single oven configuration with 450mm appliance doors top and bottom. Doors feature top central handle and bottom central handles.

FRIDGE FREEZER

Integrated Fridge Freezer with a 1245mm door featuring a bottom side left handle above and a 715mm door with top side left handle below.



MORNINGTON SHAKER EDGE

Mornington Shaker Edge in Stone and Porcelain with Matching backplates



FEATURE SHELVING UNIT

Feature shelf unit using frame profile and glass shelving.

BREAKFAST BAR

Decorative T&G breakfast bar end panel.



BESPOKE DOG BED

Using frame profile, end panels and a 139mm drawer with a top central handle.

HUNTON EDGE





REPLICATE THE LOOK

Door style: Hunton

Colour: Porcelain and Carbon

Handle style: Edge

Backplate: Matching and Carbon

Worksurface: Dekton Targa Gloss

HUNTON EDGE

Hunton Edge in Porcelain with Carbon backplates



HANDLELESS

1245mm doors used to create ultra tall wall cabinetry, with no handleless to keep the lines extra sleek.



Hunton Edge in Porcelain with Matching backplates

TOP BOXES

2 sets of 490mm top boxes with mirrored bottom side right and bottom side left handles.



OVEN HOUSING

Single oven configuration featuring set of 715mm doors with top side right and top side left below. A set of 645mm doors featuring bottom side right and bottom side left sit above.

LARDER

Pair of 1245mm doors featuring bottom side right and bottom side left handles with a pair of 715 doors featuring top side right and top side right handles underneath.

HUNTON EDGE

Hunton Edge in Porcelain with Carbon backplates



FEATURE SHELVING UNIT

Metal framed shelving units, with woodgrain MFC shelving.

715mm doors with top central handles with contrasting Carbon backplates. This monochrome contrast stands out against the matching backplate combination in the rest of the kitchen.

Hunton Edge in Carbon with Matching backplates



BESPOKE BAR

Bespoke bar area featuring 2 x 355mm drawer packs with top central handle, integrated wine fridge and 715mm door with top central handle.

STORAGE SHELF

Bespoke display shelf made from worksurface material, featuring LED uplighter.

PORTER CHANNEL & EXTENDED CHANNEL





REPLICATE THE LOOK

Door style: Porter

Colour: White and Carbon

Handle style: Channel and Extended Channel

Backplate: Matching and Walnut

Worksurface: Silestone Seaport;
Silestone Corktown

PORTER CHANNEL & EXTENDED CHANNEL

Porter Channel White with Matching backplates & Porter Extended Channel in Carbon with Walnut backplates



LARGER DOORS

1965mm doors featuring Channel fixed right and fixed left handle either side of the single ovens.

Combination of Channel and Extended Channel handles to add depth and interest to the kitchen design.



ISLAND

Minimal, linear island featuring 715mm doors.
Worksurface is used to zone island.

OVEN HOUSING

Single oven with pair of
645mm doors featuring
bottom central handles
above and 2 x sets of
355mm drawers with top
central handles below.

PORTER CHANNEL & EXTENDED CHANNEL

Series of 715mm doors with bottom central Channel handles, create tall top boxes.



LARDER DOORS

Set of 1965mm larder doors featuring fixed Extended Channel vertical right and vertical left handles.

WALK IN UTILITY AREA



BREAKFAST PANTRY

Breakfast pantry unit utilising contrasting woodgrain MFC, Blum Legrabox drawer boxes with glass fronts and Kessebohmer Tandem Side.

MICROWAVE

Integrated microwave to keep the worksurface clear.

PORTER CHANNEL & EXTENDED CHANNEL



FEATURE WORKTOP

Waterfall feature ends on the island add a seamless flow.

BREAKFAST BAR

Floating breakfast bar using built up worksurface.

OPEN STORAGE

Bespoke open storage unit housed at the end of the island provides a stark contrast to the lighter worktop.



PORTER PORTAL



REPLICATE THE LOOK

Door style: Porter

Colour: Regents Green

Handle style: Portal

Backplate: Walnut



PORTER PORTAL

Porter Portal Regents Green with Walnut backplates



WARDROBE STORAGE

An additional Linen shelf has been added to a standard wardrobe for additional storage



BESPOKE BOOKCASE

Made with colour matched end panels and feature storage units at the top and bottom of the stack.

MORNINGTON BEADED EDGE





REPLICATE THE LOOK

Door style: Mornington Beaded

Colour: Copse Green

Handle style: Edge

Backplate: Brushed Brass

MORNINGTON BEADED EDGE

Mornington Beaded Edge shown in Cope Green with Brushed Brass backplates



DOUBLE ALCOVE

Utilising the alcoves for wardrobe storage allows for seamless fitted finish around an existing chimney breast.

WORKTOP

Using a complementary green worktop (Pietra Verde) allows for a sophisticated freestanding furniture piece.

OUTLINE EDGE

Handed outline edge 3 panel doors side by side creates a focal handle detail.





BESPOKE CHEST

Create a bespoke sized chest with a mix of drawer widths, base panels, moulded plinth and worktop.

BREAKFRONT

Created by pulling the wardrobes proud of the chimney breast and using feature posts at both sides for a chunkier appearance.



PORTER EXTENDED CHANNEL

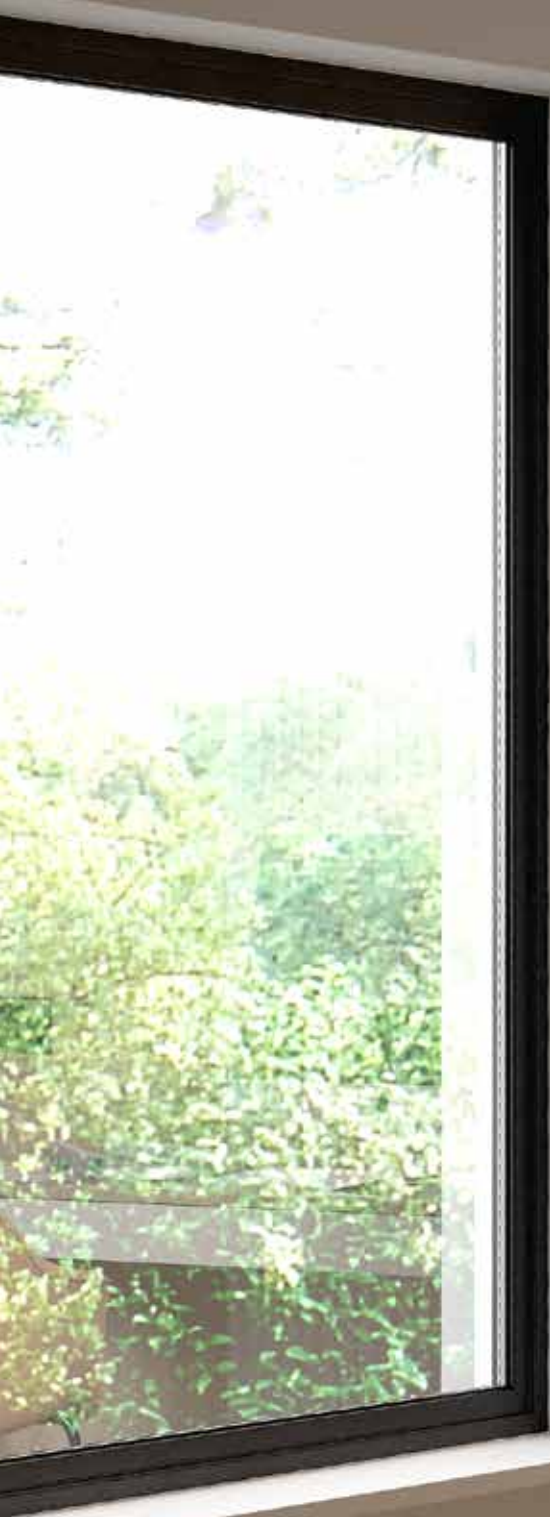

REPLICATE THE LOOK

Door style: Porter

Colour: Stone

Handle style: Extended Channel

Backplate: Copper



PORTER EXTENDED CHANNEL

Porter Extended Channel Stone with Copper backplates



DRAWERS

Drawer fronts extended channel handle shown with copper back plate.



WALL STORAGE

Wall storage created with lift up storage units and MFC open sections.



OPEN SHELVING

Create open shelving sections with MFC board and use Porter doors as panels to line through with storage.

HUNTON EDGE





REPLICATE THE LOOK

Door style: Hunton

Colour: Georgian Red

Handle style: Edge

Backplate: Brushed Brass

HUNTON EDGE

Hunton Edge Georgian Red with Brushed Brass backplates



BESPOKE STORAGE

Using feature posts and 470mm end panels creates open storage niches that allow for an additional feature showcasing decorative wallpaper through the gaps.



VANITY DRAWER

85mm high drawer used in knee hole for additional storage.

TALL STORAGE

Using 1425mm high doors on the end of the run allows for tall enclosed storage and the cross rail allows for an additional feature.



STANDARD HANDLE OPTIONS

OAK	194
WALNUT	194
CARBON	196
ANTIQUE BRONZE EFFECT	198
AGED BRASS	199
BRUSHED BRASS	200
BRIGHT COPPER	200

COMPLEMENTING HANDLES

YOU DON'T HAVE TO SPECIFY OUTLINE HANDLES ON ALL YOUR FRONTAL

Occasionally you may wish to include a handle in your design. This could be for practical reasons, to improve the functionality of a larder door or a set of wall units or to add a design feature to a section of the room such as the appliance bank or island.

Our team have carefully selected handles where the finish complements some of our backplate finishes. Of course, these are just suggestions, you can choose any of our wide collection of handles listed in our Directory.

TO COMPLEMENT

TIMBER

OAK

MALMO

Knob Handle



Code	HC	HL	PB
K1127.30.OA	Central	30	1

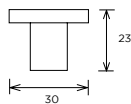

WALNUT

MALMO

Knob Handle



Code	HC	HL	PB
K1127.30.WA	Central	30	2

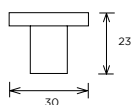

HAMSTEAD

Knob Handle



Code	HC	HL	PB
K1126.30.WABHB	Central	30	3

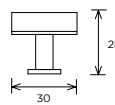

Knob Handle



Code	HC	HL	PB
K1126.30.WAMB	Central	30	3

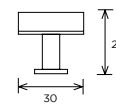



TO COMPLEMENT

CARBON

DIDSBURY COLLECTION



Code	HC	HL	PB
K1120.33.MB	Central	33mm	1

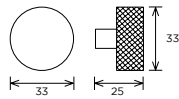

Code	HC	HL	PB
K1120.33490MB	Central	42mm	2

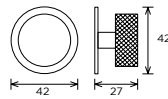

Code	HC	HL	PB
H1140.192.MB	192mm	206mm	3

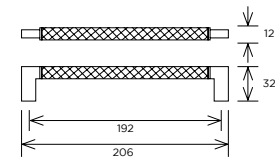

DIDSBURY COLLECTION



Code	HC	HL	PB
H1140.192491MB	192mm	222mm	3

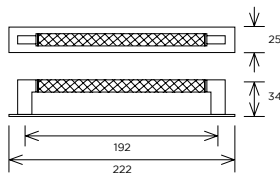

HESSAY COLLECTION



Code	HC	HL	PB
H1133.160.MB	160mm	180mm	3
H1133.320.MB	320mm	340mm	4

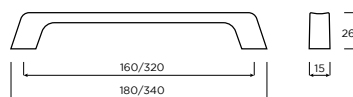

YARD COLLECTION



Code	HC	HL	PB
K1123.33.MB	Central	33mm	1

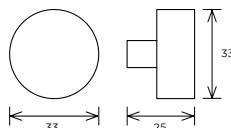

Code	HC	HL	PB
H1137.160.MB	160mm	168mm	1
H1137.224.MB	224mm	264mm	2

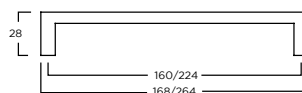

Code	HC	HL	PB
H1138.64.MB	64mm	94mm	1
H1138.160.MB	160mm	190mm	2
H1138.320.MB	320mm	350mm	3

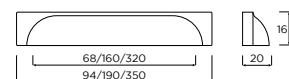



TO COMPLEMENT

METALLIC

ANTIQUÉ BRONZE EFFECT

DIDSBURY COLLECTION

Knob



Code	HC	HL	PB
K1120.33.BR	Central	33mm	1

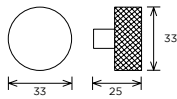

Knob



Code	HC	HL	PB
K1120.33490BR	Central	42mm	2

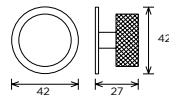

D-Handle



Code	HC	HL	PB
H1140.192.BR	192mm	206mm	3

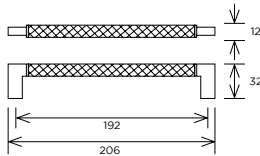

D-Handle



Code	HC	HL	PB
H1140.192491BR	192mm	222mm	3

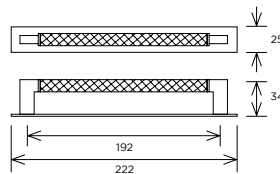

T-Bar Handle



Code	HC	HL	PB
H1158.72.BR	Central	72	2

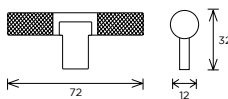

T-Bar Handle



Code	HC	HL	PB
H1158.72B496BR	Central	72	2

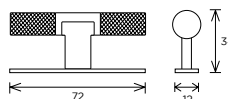

AGED BRASS

DIDSBURY COLLECTION



Code	HC	HL	PB
K1120.33.AGB	Central	33mm	1

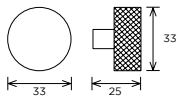

Code	HC	HL	PB
K1120.33490AGB	Central	42mm	2

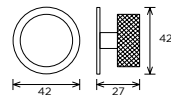

Code	HC	HL	PB
H1140.192.AGB	192mm	206mm	3

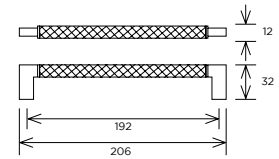

DIDSBURY COLLECTION



Code	HC	HL	PB
H1140.192491AGB	192mm	222mm	3

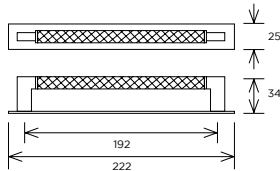

HARTON COLLECTION



Code	HC	HL	PB
H1146.105.AGB	64mm	105mm	2

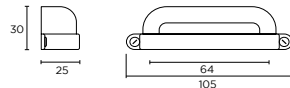

Code	HC	HL	PB
H1147.205.AGB	160mm	205mm	2

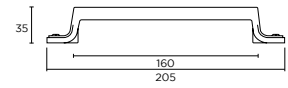

YARD COLLECTION



Code	HC	HL	PB
K1123.33.AGB	Central	33mm	1

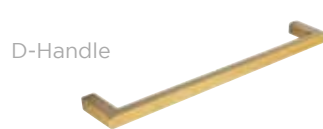
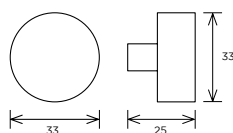

Code	HC	HL	PB
H1137.160.AGB	160mm	168mm	1
H1137.224.AGB	224mm	264mm	2

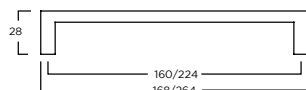

Code	HC	HL	PB
H1138.64.AGB	64mm	94mm	1
H1138.160.AGB	160mm	190mm	2
H1138.320.AGB	320mm	350mm	3

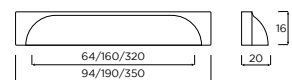

TO COMPLEMENT

METALLIC

BRUSHED BRASS

HESSAY COLLECTION

D-Handle



Code	HC	HL	PB
H1133.160.BHB	160mm	180mm	2
H1133.320.BHB	320mm	340mm	3

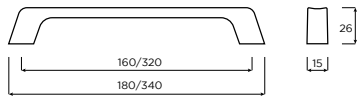

BRIGHT COPPER

YARD COLLECTION

Knob



Code	HC	HL	PB
K1123.33.CO	Central	33mm	1

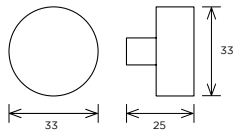

D-Handle



Code	HC	HL	PB
H1137.160.CO	160mm	168mm	1
H1137.224.CO	224mm	264mm	2

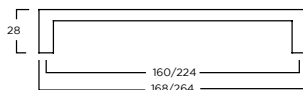

HESSAY COLLECTION

D-Handle



Code	HC	HL	PB
H1133.160.CO	160mm	180mm	2
H1133.320.CO	320mm	340mm	3

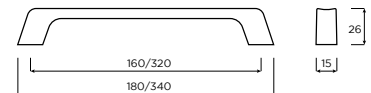



HELPING YOU SELL OUTLINE

We have compiled a comprehensive support package to help you to design, order and sell Outline kitchens. This includes dedicated brochures, printed manuals, in-store POS and digital support.

For more information and to order any of the items below please contact your Account Manager.



CONSUMER BROCHURE

A dedicated brochure for you to promote Outline to your customers. Featuring dedicated sets for each handle type and an overview of all the whole collection, with your help this brochure can help consumers create their dream kitchen.



TRADE MANUAL

We've created this comprehensive manual to guide you through each step of the process. With in-depth product information to help you design, order and plan, this document gives you and your teams the confidence to design and order Outline kitchens.

STOCKED ONLINE SAMPLES

To help you show your customers the benefits of Outline we stock a number of samples doors in a wide selection of frontal families and colours, all featuring an Outline handle option and backplate.



PXO574SAMPLE/RM
Shown for illustration
purpose only

INDIVIDUAL SAMPLES

PXO574SAMPLE/RM	Porter Outline sample door, 570x397mm, Regiment, Portal Matching backplate, top central
PSO574SAMPLE/GE	Porter Outline sample door, 570x397mm, Graphite, Extended Channel with Walnut backplate, top central
PSO574SAMPLE/WC	Porter Outline sample door, 570x397mm, White, Channel with Carbon Backplate
HSO574SAMPLE/HA	Hunton Outline sample door, 570x397mm, Hartforth Blue, Edge with Aged Brass backplate, top central
MBSO574SAMPLESM	Mornington Beaded Outline sample door 570x397mm, Stone, Edge with Matching backplate

SET OF ALL 5 SAMPLES

OUTLINE/SAMPLE	Set of 5 Outline Sample Doors, 570x397mm
----------------	--



CONFIGURATOR

We have built an Outline Configurator so you and your customers can explore the wealth of Outline kitchens available.

Available online at www.pws.co.uk/outline, this handy tool is the easiest way to explore our collection, discover all the door styles, available colours, and selection of backplates.



EASY ORDERING PLATFORM

The easiest way to order Outline is online. Effortlessly browse and order products anytime from any location using our easy-to-use step-by-step ordering platform.

Visit www.pws.co.uk to order.

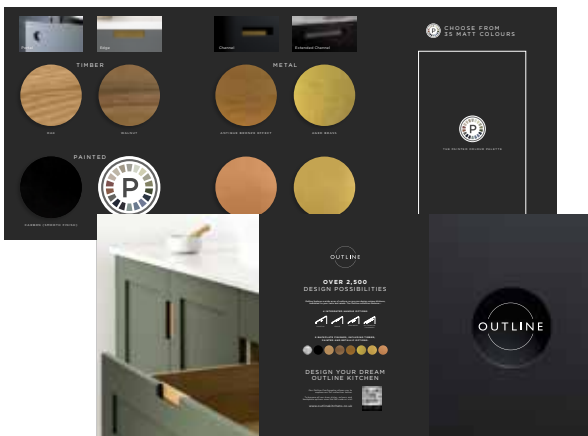

POS SUPPORT

Premium point-of-sale folder that allows you to demonstrate the breath of options available to customers. Users can mix and match backplate and paint colours to discover they're favourites.



BEST-IN-CLASS IMAGERY

We have created a suite of industry-leading imagery for use in-store, in print and online. You can download a variety of images from a selection of Outline sets. Download anything you want, whenever you want.

Contact your Account Manager to order any of the items above and discuss how we can support you.



July 2022

PWS



www.pws.co.uk

PWS Distributors Ltd
PO BOX 20, Station Road
Aycliffe Business Park
Newton Aycliffe
Co. Durham DL5 6XJ, UK

T: +44(0)1325 505599
E: sales-support@pws.co.uk